

BS EN 62471-5:2015



BSI Standards Publication

<http://www.china-gauges.com/>

Photobiological safety of lamps and lamp systems —

Part 5: Image projectors

bsi.

...making excellence a habit.™

National foreword

This British Standard is the UK implementation of EN 62471-5:2015. It is identical to IEC 62471-5:2015.

The UK participation in its preparation was entrusted to Technical Committee EPL/76, Optical radiation safety and laser equipment.

A list of organizations represented on this committee can be obtained on request to its secretary.

This publication does not purport to include all the necessary provisions of a contract. Users are responsible for its correct application.

© The British Standards Institution 2015.

Published by BSI Standards Limited 2015

ISBN 978 0 580 83757 9

BSI 2015

Compliance with a British Standard cannot confer immunity from legal obligations.

This British Standard was published under the authority of the Standards Policy and Strategy Committee on 31 October 2015.

Amendments/corrigenda issued since publication

Date	Text affected
------	---------------

EUROPEAN STANDARD
NORME EUROPÉENNE
EUROPÄISCHE NORM

EN 62471-5

October 2015

ICS 29.140

English Version

Photobiological safety of lamps and lamp systems - Part 5:
Image projectors
(IEC 62471-5:2015)

Sécurité photobiologique des lampes et des appareils
utilisant des lampes - Partie 5: Projecteurs d'images
(IEC 62471-5:2015)

Photobiologische Sicherheit von Lampen und
Lampensystemen - Teil 5: Photobiologische Sicherheit von
Lampensystemen für Bildprojektoren
(IEC 62471-5:2015)

This European Standard was approved by CENELEC on 2015-07-14. CENELEC members are bound to comply with the CEN/CENELEC Internal Regulations which stipulate the conditions for giving this European Standard the status of a national standard without any alteration.

Up-to-date lists and bibliographical references concerning such national standards may be obtained on application to the CEN-CENELEC Management Centre or to any CENELEC member.

This European Standard exists in three official versions (English, French, German). A version in any other language made by translation under the responsibility of a CENELEC member into its own language and notified to the CEN-CENELEC Management Centre has the same status as the official versions.

CENELEC members are the national electrotechnical committees of Austria, Belgium, Bulgaria, Croatia, Cyprus, the Czech Republic, Denmark, Estonia, Finland, Former Yugoslav Republic of Macedonia, France, Germany, Greece, Hungary, Iceland, Ireland, Italy, Latvia, Lithuania, Luxembourg, Malta, the Netherlands, Norway, Poland, Portugal, Romania, Slovakia, Slovenia, Spain, Sweden, Switzerland, Turkey and the United Kingdom.



European Committee for Electrotechnical Standardization
Comité Européen de Normalisation Electrotechnique
Europäisches Komitee für Elektrotechnische Normung

CEN-CENELEC Management Centre: Avenue Marnix 17, B-1000 Brussels

European Foreword

The text of document 76/519/FDIS, future edition 1 of IEC 62471-5, prepared by IEC/TC 76 "Optical radiation safety and laser equipment" was submitted to the IEC-CENELEC parallel vote and approved by CENELEC as EN 62471-5:2015.

The following dates are fixed:

- latest date by which the document has to be implemented at national level by publication of an identical national standard or by endorsement (dgn) 2016-04-16
- latest date by which the national standards conflicting with the document have to be withdrawn (dow) 2018-07-14

Attention is drawn to the possibility that some of the elements of this document may be the subject of patent rights. CENELEC [and/or CEN] shall not be held responsible for identifying any or all such patent rights.

Endorsement notice

The text of the International Standard IEC 62471-5:2015 was approved by CENELEC as a European Standard without any modification.

Annex ZA (normative)

Normative references to international publications with their corresponding European publications

The following documents, in whole or in part, are normatively referenced in this document and are indispensable for its application. For dated references, only the edition cited applies. For undated references, the latest edition of the referenced document (including any amendments) applies.

NOTE 1 When an International Publication has been modified by common modifications, indicated by (mod), the relevant EN/HD applies.

NOTE 2 Up-to-date information on the latest versions of the European Standards listed in this annex is available here: www.cenelec.eu.

<u>Publication</u>	<u>Year</u> series	<u>Title</u>	<u>EN/HD</u>	<u>Year</u> series
IEC 60050		International Electrotechnical Vocabulary - -		
IEC 60065	-	Audio, video and similar electronic apparatus - Safety requirements	EN 60065	-
IEC 60825-1	2014	Safety of laser products -- Part 1: Equipment classification and requirements	EN 60825-1	2014
IEC 60950-1	-	Information technology equipment - Safety -- Part 1: General requirements	EN 60950-1	-
IEC 62471	-	Photobiological safety of lamps and lamp systems	EN 62471	-

CONTENTS

FOREWORD.....	5
INTRODUCTION.....	7
1 Scope.....	8
2 Normative references.....	8
3 Terms and definitions	9
4 General	15
4.1 Basis for risk groups	15
4.2 Example applications	16
4.2.1 RG0 / RG1 projectors.....	16
4.2.2 RG2 projectors.....	16
4.2.3 RG3 projectors.....	16
4.3 Projector lamps.....	16
4.4 Assessment criteria (background).....	16
5 Risk group determination	17
5.1 Test conditions.....	17
5.2 Measurement conditions for image projectors	18
5.2.1 Measurement throw ratio	18
5.2.2 Measurement distance	18
5.3 The position and size of apparent source, the calculation of angular subtense.....	18
5.4 Measurement of irradiance – specified apertures	19
5.5 Measurement of radiance	19
5.6 Accessible emission limits	20
5.6.1 For CW emission.....	20
5.6.2 For pulsed emission	21
5.6.3 Spectral weighting functions.....	22
5.7 Applying information from the lamp manufacturers	23
5.7.1 General	23
5.7.2 Limits provided in irradiance/radiant exposure	24
5.7.3 Limits provided in radiance or radiance dose	24
6 Manufacturer's requirements.....	24
6.1 General.....	24
6.2 Determination of HD (hazard distance)	25
6.3 Safety feature "soft start"	25
6.4 Optional safety features	25
6.4.1 Projection of warning message.....	25
6.4.2 Power reduction by sensor system	25
6.5 Labelling on products	25
6.5.1 General	25
6.5.2 RG0 projector	26
6.5.3 RG1 projector	26
6.5.4 RG2 projector	27
6.5.5 RG3 projector	28
6.6 User information.....	28
6.6.1 General	28
6.6.2 Assessment of user accessible area.....	29

6.6.3	User information (user manual)	29
6.6.4	User information for maintenance	30
6.7	Labelling and user information for image projectors where the risk group will be changed by interchangeable lens	30
6.7.1	General	30
6.7.2	Labelling on the projector	30
6.7.3	Mark on the interchangeable lens	32
6.7.4	The user information in the user manual of the projector	32
6.7.5	The user information in the user manual of the interchangeable lens	32
7	Information for service	33
Annex A (normative)	Test scheme for lamp types	34
Annex B (informative)	Example of calculations	35
B.1	Radiance calculations	35
B.1.1	General	35
B.1.2	Calculation from measured irradiance	35
B.1.3	Calculation from luminous output	36
B.2	Calculation example of risk group (CW)	37
B.2.1	Example of a 5 000 lm projector	37
B.2.2	10 000 lm professional-use projector with an apparent source of small subtense angle (CW)	39
B.2.3	2 000 lm projector with small apparent source (CW)	40
B.3	Calculation example of risk group (pulsed emission)	41
B.3.1	General	41
B.3.2	14 000 lm projector with one peak	41
B.3.3	14 000 lm projector with two peaks	44
Annex C (informative)	Example of intra-beam of projector sources with millimetre scale	47
Annex D (informative)	Measurement distance	48
Annex E (informative)	Hazard distance as a function of modifying optics	50
Bibliography	51
Figure 1	– Exit pupil in projector	10
Figure 2	– Examples of the application of the definition of pulse duration	13
Figure 3	– Definition of throw ratio	15
Figure 4	– Diameter of the apparent source	18
Figure 5	– RG1 label (optional)	26
Figure 6	– RG2 label	27
Figure 7	– RG2 caution symbol	27
Figure 8	– Sample design of RG2 caution pictogram	27
Figure 9	– RG3 label	28
Figure 10	– Optical radiation warning symbol	28
Figure 11	– "Not for household use" symbol	28
Figure 12	– RG2 label with the caution for RG3	31
Figure 13	– RG2 caution label with the caution for RG3	31
Figure 14	– RG2 pictogram with the caution for RG3	32
Figure B.1	– Image of the apparent source and measurement condition	37

Figure B.2 – Picture of the apparent source of a projector at the exit pupil of the projection lenses with a scale.....	37
Figure B.3 – Example with one peak of pulsed emission	42
Figure B.4 – Example with two peaks of pulsed emission.....	44
Figure C.1 – Examples of intra-beam images of projector sources with millimetre scale.....	47
Figure E.1 – Hazard distance as a function of modifying optics (example).....	50
Table 1 – Measurement criteria — field of view (angles of acceptance) for CW source	19
Table 2 – Measurement criteria — field of view (angles of acceptance) for pulsed source	19
Table 3 – AEL (accessible emission limit) for risk groups of lamps and lamp systems emitting CW optical radiation.....	20
Table 4 – Time base values associated with the risk groups and hazards.....	20
Table 5 – Basic retinal thermal emission limit	20
Table 6 – The values of C_5 and α for AEL calculation	21
Table 7 – Pulse duration dependent values of α_{\max}	22
Table 8 – Spectral weighting functions $B(\lambda)$ and $R(\lambda)$ for assessing retinal hazards	23
Table 9 – Labelling on products	26
Table 10 – User information in user manual.....	29
Table A.1 –Required evaluations.....	34

INTERNATIONAL ELECTROTECHNICAL COMMISSION

PHOTOBIOLOGICAL SAFETY OF LAMPS AND LAMP SYSTEMS –

Part 5: Image projectors

FOREWORD

- 1) The International Electrotechnical Commission (IEC) is a worldwide organization for standardization comprising all national electrotechnical committees (IEC National Committees). The object of IEC is to promote international co-operation on all questions concerning standardization in the electrical and electronic fields. To this end and in addition to other activities, IEC publishes International Standards, Technical Specifications, Technical Reports, Publicly Available Specifications (PAS) and Guides (hereafter referred to as "IEC Publication(s)"). Their preparation is entrusted to technical committees; any IEC National Committee interested in the subject dealt with may participate in this preparatory work. International, governmental and non-governmental organizations liaising with the IEC also participate in this preparation. IEC collaborates closely with the International Organization for Standardization (ISO) in accordance with conditions determined by agreement between the two organizations.
- 2) The formal decisions or agreements of IEC on technical matters express, as nearly as possible, an international consensus of opinion on the relevant subjects since each technical committee has representation from all interested IEC National Committees.
- 3) IEC Publications have the form of recommendations for international use and are accepted by IEC National Committees in that sense. While all reasonable efforts are made to ensure that the technical content of IEC Publications is accurate, IEC cannot be held responsible for the way in which they are used or for any misinterpretation by any end user.
- 4) In order to promote international uniformity, IEC National Committees undertake to apply IEC Publications transparently to the maximum extent possible in their national and regional publications. Any divergence between any IEC Publication and the corresponding national or regional publication shall be clearly indicated in the latter.
- 5) IEC itself does not provide any attestation of conformity. Independent certification bodies provide conformity assessment services and, in some areas, access to IEC marks of conformity. IEC is not responsible for any services carried out by independent certification bodies.
- 6) All users should ensure that they have the latest edition of this publication.
- 7) No liability shall attach to IEC or its directors, employees, servants or agents including individual experts and members of its technical committees and IEC National Committees for any personal injury, property damage or other damage of any nature whatsoever, whether direct or indirect, or for costs (including legal fees) and expenses arising out of the publication, use of, or reliance upon, this IEC Publication or any other IEC Publications.
- 8) Attention is drawn to the Normative references cited in this publication. Use of the referenced publications is indispensable for the correct application of this publication.
- 9) Attention is drawn to the possibility that some of the elements of this IEC Publication may be the subject of patent rights. IEC shall not be held responsible for identifying any or all such patent rights.

International Standard IEC 62471-5 has been prepared by IEC technical committee 76: Optical radiation safety and laser equipment.

The text of this standard is based on the following documents:

FDIS	Report on voting
76/519/FDIS	76/521/RVD

Full information on the voting for the approval of this standard can be found in the report on voting indicated in the above table.

This publication has been drafted in accordance with the ISO/IEC Directives, Part 2.

The committee has decided that the contents of this publication will remain unchanged until the stability date indicated on the IEC web site under "<http://webstore.iec.ch>" in the data related to the specific publication. At this date, the publication will be

- reconfirmed,
- withdrawn,
- replaced by a revised edition, or
- amended.

A bilingual version of this publication may be issued at a later date.

IMPORTANT – The 'colour inside' logo on the cover page of this publication indicates that it contains colours which are considered to be useful for the correct understanding of its contents. Users should therefore print this document using a colour printer.

INTRODUCTION

Most lamps and lamp systems are safe and do not pose photobiological risks except under unusual exposure conditions. This also is the case for optical image projectors where experience shows that even high power cinema projectors may be safe for accidental momentary viewing and can only under some conditions pose optical hazards at close distances or for intentional 'long-duration' staring into the source. The rapid development of solid-state and other lamps or lamp systems has permitted new product products, and generated the need for a photobiological safety standard for this group of lamp systems.

Optical radiation hazards from all types of lamps and lamp systems are currently assessed by the application of IEC 62471:2006 (CIE S 009:2002), *Photobiological safety of lamps and lamp systems*. IEC 62471 covers LEDs, incandescent, low- and high-pressure gas-discharge, arc and other lamps. Following the concept of vertical standards, the risk group classification system in IEC 62471 for lamps is to be adapted for specific product groups such as image projectors.

This part of IEC 62471 provides a risk group classification system for image projectors, and measurement conditions for optical radiation emitted by image projectors. It includes manufacturing requirements that may be required as a result of an image projector system being assigned to a particular risk group. Therefore, this part of IEC 62471 provides safety requirements for lamp systems that are intended to produce projected visible optical radiation, such as theatre projectors, data projectors and home-use projectors. The assigned risk group of a projector product also may be used by projector manufacturers to assist with any risk assessments, e.g. for occupational exposure in workplaces. National requirements may exist for the assessment of products or occupational exposure.

The emission limits provided in this part of IEC 62471 are derived from the exposure limits specified by ICNIRP in their 2013 Guidelines for incoherent visible and infrared radiation [1]¹. These exposure limits are also the basis for the emission limits to be specified in the future International Standard IEC 62471-1².

¹ Numbers in square brackets refer to the Bibliography.

² Revision of IEC 62471:2006.

PHOTOBIOLOGICAL SAFETY OF LAMPS AND LAMP SYSTEMS –

Part 5: Image projectors

1 Scope

This part of IEC 62471 provides requirements regarding photobiological safety of the optical radiation emitted by image projectors. This part of IEC 62471 does not deal with other hazards such as electrical, mechanical or fire hazards.

This part of IEC 62471 provides requirements regarding:

- optical radiation safety assessment of image projectors;
- projector risk groups;
- testing conditions and measurement conditions;
- manufacturer's requirements including user information.

The scope of this part of IEC 62471 is photobiological safety of image projectors including the emissions from laser-illuminated projectors that fulfill the requirements as specified in IEC 60825-1:2014, 4.4 and for which visible light emission has been excluded from classification in IEC 60825-1.

This part of IEC 62471 does not address safety requirements for laser display products where collimated laser beams — generally scanned — are employed. It does address those laser-illuminated projectors that employ a laser source to illuminate, for example, a micro-electro-mechanical system (MEMS) without scanned beams or crystal-based display projector system.

NOTE Image projectors containing lasers are subject to those provisions of IEC 60825-1 applicable to the embedded laser. See IEC 60825-1:2014, 4.4 for which visible light emission has been excluded from the laser product classification.

This part of IEC 62471 includes projectors for only visible image projection and does not include ultraviolet (UV) projectors, infrared (IR) projectors, general lighting service (GLS) lamps (GLS; defined in IEC 62471) or projector lamp systems used for general lighting, which are treated in separate International Standards.

2 Normative references

The following documents, in whole or in part, are normatively referenced in this document and are indispensable for its application. For dated references, only the edition cited applies. For undated references, the latest edition of the referenced document (including any amendments) applies.

IEC 62471, *Photobiological safety of lamps and lamp systems*

IEC 60825-1:2014, *Safety of laser products – Part 1: Equipment classification and requirements*

IEC 60050 (all parts), *International Electrotechnical Vocabulary* (available at <http://www.electropedia.org>)

IEC 60950-1, *Information technology equipment – Safety – Part 1: General requirements*

IEC 60065, *Audio, video and similar electronic apparatus – Safety requirements*

3 Terms and definitions

For the purposes of this document, the terms and definitions given in IEC 62471, IEC 60050-845 [2] and the following apply.

3.1

accessible emission

AE

level of radiation determined at a certain distance from the product and with measurement conditions described in Clause 5

Note 1 to entry: The accessible emission is compared with the AEL (see 3.2) to determine the risk group of the product.

3.2

accessible emission limit

AEL

maximum accessible emission permitted within a particular risk group

3.3

angle of acceptance

γ

plane angle within which a detector will respond to optical radiation

Note 1 to entry: The angle of acceptance is usually measured in radians (SI unit).

Note 2 to entry: This angle of acceptance may be controlled by apertures or optical elements in front of the detector. The angle of acceptance is also sometimes referred to as the field of view (see 3.12).

Note 3 to entry: The angle of acceptance should not be confused with the angular subtense of the source (see 3.4) or the beam divergence.

3.4

angular subtense

α

visual angle subtended by the apparent source at the eye of an observer or at the point of measurement

Note 1 to entry: In this part of IEC 62471, subtended angles are denoted by the full included angle, not the half angle.

Note 2 to entry: SI unit: radian.

Note 3 to entry: The angular subtense α may be modified by incorporation of lenses and mirrors as projector optics, i.e. the angular subtense of the apparent source may differ from the angular subtense of the physical source.

Note 4 to entry: The limitations of α in this part of IEC 62471 are:

For continuous wave: $\alpha_{\max} = 0,1$ rad, $\alpha_{\min} = 0,001\ 5$ rad.

For pulsed emission: α_{\max} is described in Table 7, $\alpha_{\min} = 0,001\ 5$ rad.

3.5

cinema-use projector

image projector used for projection in theatrical environment

3.6

consumer product

item intended for consumers or likely to be used by consumers, even if not intended for them

Note 1 to entry: Products provided in the framework of a service to consumers are also considered to be consumer products.

Note 2 to entry: RG3 products are intended for professional use only, and are not intended for consumer use.

3.7 continuous wave emission

CW emission

emission of a projector which can be considered continuous when the output is continuous for times greater than 0,25 s and the peak radiated power is not more than 1,5 times the average radiated power

3.8 data projector

image projector system using digital imager(s) routinely employed in offices, meetings and sales presentations

Note 1 to entry: Examples of data imager are MEMS and liquid crystal based display.

3.9 exit pupil

image of the aperture stop which also functions as a virtual aperture of the projection lens

Note 1 to entry: The position of the apparent source is located at the apparent position of the exit pupil (see Figure 1).

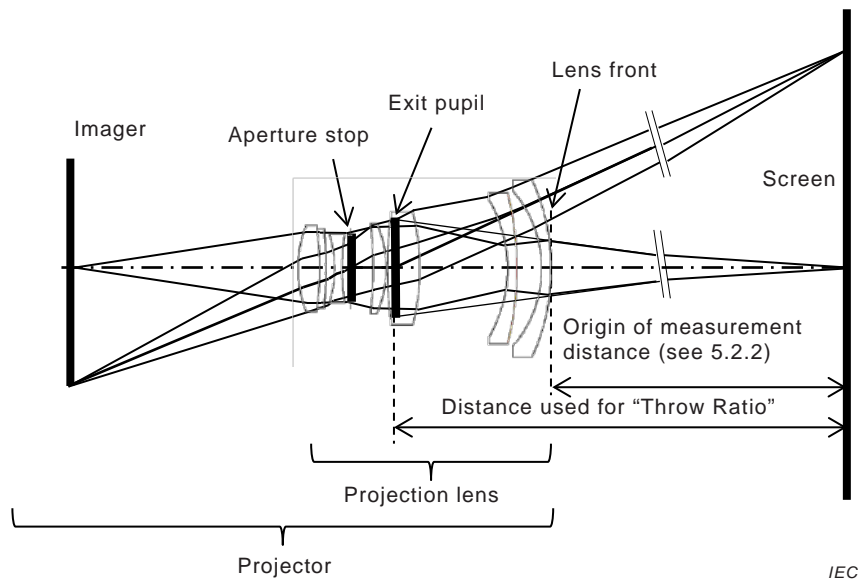

Figure 1 – Exit pupil in projector

3.10 exposure limit

EL

maximum level of exposure of optical radiation to the eye or skin that is not expected to result in adverse biological effects

Note 1 to entry: These ELs are used to determine hazard distances with respect to photobiological effects.

3.11 exposure to limit ratio

ELR

ratio of the exposure level and the exposure limit

Note 1 to entry: Since both values can be functions of distance and exposure duration, the ELR can depend on exposure distance and exposure duration.

3.12

field of view

γ

solid angle as "seen" by the detector (acceptance angle), for example of a radiometer or spectroradiometer, out of which the detector receives radiation

Note 1 to entry: SI unit: steradian (sr).

Note 2 to entry: The field of view should not be confused with the angular subtense of the apparent source, α .

Note 3 to entry: A plane angle is sometimes used to describe a circular symmetric solid angle field of view.

Note 4 to entry: The field of view is sometimes referred to as angle of acceptance (see 3.3).

3.13

fixed projector installation

projector installed permanently or semi-permanently in a fixed location

EXAMPLE A cinema-use projector mounted in an operating booth.

3.14

hazard distance

HD

distance from the projector's nearest point of human access, where the beam radiance or irradiance exceeds the applicable exposure limit (EL: see 3.10)

Note 1 to entry: The hazard distance for a projector is determined by the EL for a 0,25 s exposure. This also is the time base of the accessible emission limit of RG2.

3.15

home-use projector

image projector used for audio-visual presentations in the domestic environment under non-controlled conditions and non-professional use

3.16

image projector product

member of the family of products that includes all types of image projectors such as data projectors (see 3.8), home-use projectors (see 3.15) and cinema-use projectors (see 3.5)

3.17

intended use

usage of a product, process or application in accordance with specifications, instructions and information provided by the manufacturer or supplier

3.18

lamp

electrically powered device emitting optical radiation in the wavelength range between 200 nm and 3 000 nm, with the exception of direct, non-diffuse laser radiation

3.19

lamp system

electrically operated product incorporating lamp(s), including fixtures, projection optics and incorporated electrical or electronic components as intended by the manufacturer

Note 1 to entry: A lamp system can include diffusers, enclosures and/or beam modifying optics. An image projector (see 3.16) is a type of lamp system.

3.20**laser illuminated projecting system
LIP system**

projection lamp system emitting visible diffused light as a result of laser light source(s) in order to replace traditional projector lamps

3.21**light emitting diode
LED**

solid-state lamp device embodying a p-n junction, emitting incoherent optical radiation when excited by an electric current

3.22**liquid-crystal display projector
LCD projector**

projector employing an LCD digitized image panel that is projected by the system

3.23**micro-electro-mechanical system based imager
MEMS based imager**

micro-electro-mechanical system with electro-optical arrays of micro-mirrors

3.24**modifying optics**

optical components that process the light, such as filters, lenses and reflectors, which change the characteristics of the optical radiation from the initial light source when incorporated into an image projector (see 3.16)

3.25**projector**

optical system using reflection and/or refraction to increase the luminous intensity within a limited solid angle

Note 1 to entry: The light emitted into a limited solid-angle is generally referred to as the “beam”.

Note 2 to entry: The emitted beam is intended to be incident on a screen or some other diffuse surface such as a house or room wall.

3.26**projector lamp**

lamp in which the luminous element is mounted in such a way that the lamp may be used with an optical system to project the light in chosen directions

3.27**pulse duration**

t_p
time increment calculated by D/L_{peak} where D is the total radiance dose of the pulse and L_{peak} is the peak radiance of that pulse (see Figure 2)

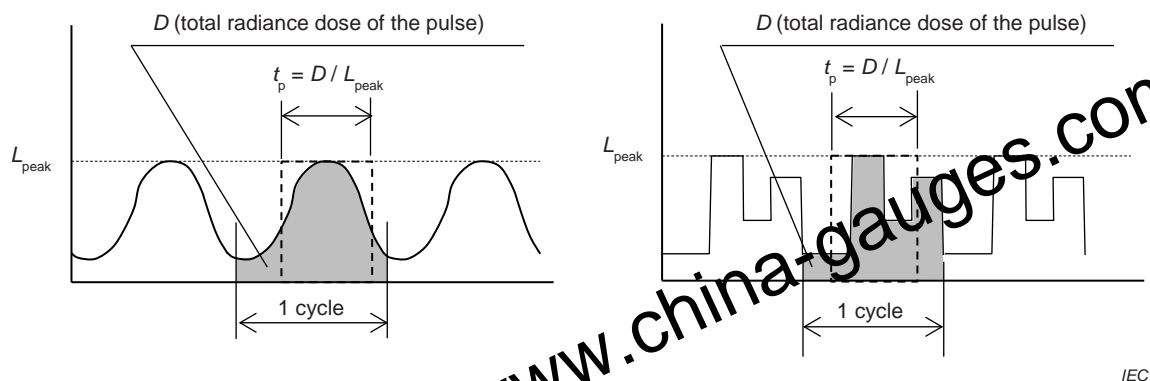

Figure 2 – Examples of the application of the definition of pulse duration

Note 1 to entry: Unit: second (s).

Note 2 to entry: For a pulse that has a triangular or rectangular temporal emission shape, this definition of pulse duration is identical to the full-width-half-maximum (FWHM) definition.

Note 3 to entry: A rectangular pulse, shown with dashed borders in Figure 2, with the pulse duration t_p has the same radiance dose and peak radiance as the actual pulse.

3.28 pulsed emission

emission in the form of a single pulse or a train of pulses where each pulse is assumed to have a duration of less than 0,25 s

Note 1 to entry: Pulsed emission refers to a product with a continuous train of pulses or modulated radiant energy where the peak radiated power is at least 1,5 times higher than the average radiated power.

3.29 radiance

L
quantity defined by the formula

$$L = d\Phi / (dA \cdot \cos\theta \cdot d\Omega)$$

in a given direction at a given point of a real or imaginary surface,

where

$d\Phi$ is the radiant power (flux) transmitted by an elementary beam passing through the given point and propagating in the solid angle ($d\Omega$) containing the given direction;

dA is the area of a section of that beam containing the given point;

θ is the angle between the normal to that section and the direction of the beam

Note 1 to entry: SI unit: watt per square metre per steradian ($\text{W} \cdot \text{m}^{-2} \cdot \text{sr}^{-1}$).

3.30 radiance dose

D
time integrated radiance quantity defined by the equation

$$D = dQ_e / (dA \cdot \cos\theta \cdot d\Omega)$$

where

dQ_e is the radiant energy transmitted by an elementary beam passing through the given point and propagating in the solid angle ($d\Omega$) containing the given direction;

dA is the area of a section of that beam containing the given point;

θ is the angle between the normal to that section and the direction of the beam

Note 1 to entry: SI unit: joule per square metre per steradian ($\text{J}\cdot\text{m}^{-2}\cdot\text{sr}^{-1}$).

Note 2 to entry: Equivalent term: “(time) integrated radiance”.

3.31

restricted area

area where an engineering and/or administrative control measure is established to restrict access except to authorized personnel with appropriate safety training

Note 1 to entry: Access is only possible through the use of a tool, lock, key or other means of security.

3.32

spatially averaged radiance

L_{sa}
quantity defined by the equation

$$L_{sa} = d\Phi / (dA_y \cdot \cos\theta \cdot d\Omega)$$

radiance spatially averaged over a given angle of acceptance to account for physiological factors such as eye-movements (sometimes referred to as “physiological radiance”)

where

$d\Phi$ is the radiant power (flux);

dA_y is limited by area of field of view (see 3.12);

θ is the angle between the normal to that section and the direction of the beam;

$d\Omega$ is the solid angle

Note 1 to entry: SI unit: watt per square metre per steradian ($\text{W}\cdot\text{m}^{-2}\cdot\text{sr}^{-1}$).

Note 2 to entry: The spatially averaged radiance may be lower than the true source radiance (see 3.34).

3.33

throw ratio

TR

ratio between the distance from the exit pupil to the screen and the width of the image on the screen

Note 1 to entry: It is thus approximated by the inverse of the tangent of the full angle of the light beam in the horizontal direction (see Figure 3).

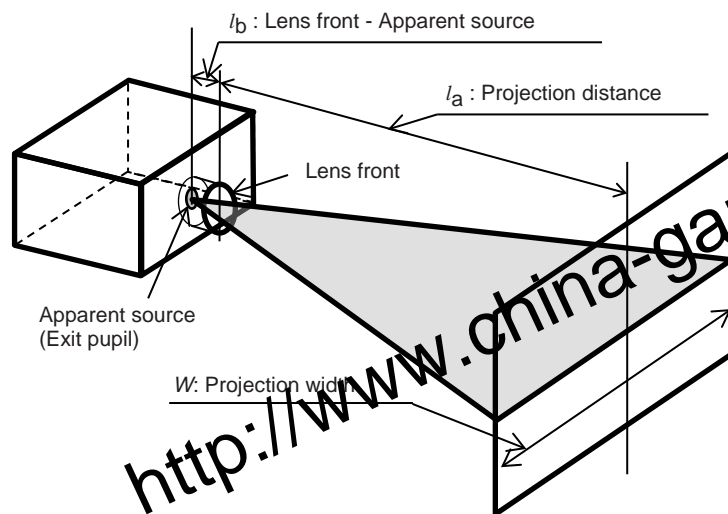

IEC

Figure 3 – Definition of throw ratio

Note 2 to entry: $TR = (l_a + l_b)/W$.

3.34

true source radiance

L

radiance of the emitting element of the source, physically measured

Note 1 to entry: The applicable averaging angle of acceptance for the determination of radiance shall not be larger than 1,5 mrad.

Note 2 to entry: SI unit: watt per square metre per steradian ($W \cdot m^{-2} \cdot sr^{-1}$).

Note 3 to entry: This definition differs from spatially averaged radiance (see 3.32). This is a quantity that is useful as information regarding the projector light source (see 5.7.3). For the spatially averaged radiance, the given angle of acceptance should have a value as defined in Table 1 or Table 2. This value is defined based on physiological factors. While the true source radiance should be averaged over a small angle in order to be more accurate, the maximum allowed averaging angle is defined to 1,5 mrad.

3.35

unintentional viewing

condition when ocular exposure to optical radiation is not intended

4 General

4.1 Basis for risk groups

IEC 62471 provides the default method to determine the risk group of any lamp or any product incorporating a lamp, unless a vertical (application-specific) standard exists. The risk groups in IEC 62471 indicate the degree of risk from potential optical radiation hazards and minimize the need for further measurements. The risk groups were developed based upon decades of lamp use experience and the analysis of accidental injuries related to optical radiation emission (where injuries were generally quite rare except from, for example, ultraviolet-emitting lamps or arc lamps).

The risk groups are described as follows:

- Exempt Group (RG0) where no optical hazard is considered reasonably foreseeable, even for continuous, unrestricted use.
- Risk Group 1 (RG1) products are safe for most applications, except for very prolonged direct ocular exposures (staring into the source for very long times, greater than 100 s).

- Risk Group 2 (RG2) products do not pose an optical hazard because of aversion responses to bright light which make long exposures (staring into the source) not reasonably foreseeable. RG2 projectors can be safely used in all situations, except if intrabeam (direct) viewing is intended.
- Risk Group 3 (RG3) products pose a potential hazard even for momentary exposures at close distance and product safety requirements are generally essential. RG3 projectors pose a risk resulting from direct, intra-beam viewing at close distance. Use information on protective measures shall be provided. The RG3 projector products require controlled use or special installation (for example, theatre projectors), and user instructions should clearly state the HD and the requirement for supervised use or special installation. From the labelling and information for the user, the user should recognize the risk and take protective measures.

RG3 products are intended for professional use only, and are not intended for consumer use.

4.2 Example applications

4.2.1 RG0 / RG1 projectors

Typical examples are conventional tungsten halogen slide or film projectors for home use or pico-projectors.

4.2.2 RG2 projectors

For example, home-use projectors or mobile projectors may be RG2 projectors.

4.2.3 RG3 projectors

For example, high luminance projection systems used in cinemas or theatres may be RG3 projectors. Rental projectors for professional staging applications, seminars and other big events may also be RG3 projectors.

4.3 Projector lamps

It should be noted that the risk group classification system of IEC 62471 in its current version is primarily applied to lamps. However, manufacturers of image projectors have the responsibility for assessing the final product. They may have limited capabilities for tests and measurements and may need to rely on the lamp data provided by the lamp manufacturer. Therefore, guidance is provided in 5.7 on how and when projector system manufacturers may rely on data provided by the lamp manufacturer.

4.4 Assessment criteria (background)

The standard measurement conditions consider the emission spectrum and, depending on the hazard, either irradiance or spatially averaged radiance to determine risk to the eye and/or the skin. The measurement conditions are related to potentially hazardous exposure conditions and potential direct-viewing conditions and take into consideration physiological factors of the eye, such as accommodation, pupil size and the aversion response.

Assessment and measurement conditions necessarily differ for different special application lamp systems, such as image projector products. Different application groups define a range of operational, maintenance and servicing conditions. The assessment applied to image projectors (as a specific type of lamp system) in this vertical standard justifies somewhat different measurement conditions than those in IEC 62471 for lamps. The requirements in this application-specific (vertical) standard limit the product risk group that can be used in some specific applications, such as in domestic environments or in schools. Performance features are based upon the risk group specifications and application-specific control measures. Basic guidance, based on the likelihood of direct source viewing, is provided in Clause 6. The hierarchy of applicable safety measures follow the internationally accepted priority ranking of manufacturer safety measures. Engineering controls (filters, shielding, etc.) have the highest

priority, followed by collective organizational measures, and finally, only if the above measures are not practical to reduce the risk to a tolerable level, personal protective equipment.

Multiple limit values are specified in this safety standard to reflect different photobiological hazards. Each of these limits, in principle, must be evaluated against the respective accessible emission separately (see Annex A). The limit values are expressed as irradiance or radiance.

Each risk group is associated with different time bases as found in Table 4.

To determine the risk group, the accessible emission must be first determined and then the accessible emission is compared against the AEL values provided in Table 3 for the time bases provided in Table 4 (see Annex A).

- The product is RG0 (Exempt Group) if no accessible emission exceeds the RG0 AELs.
- The product is RG1 if any accessible emission exceeds the RG0 AELs but no accessible emission exceeds the RG1 AELs.
- The product is RG2 if any accessible emission exceeds the RG1 AELs but no accessible emission exceeds the RG2 AELs.
- The product is RG3 if any accessible emission exceeds the RG2 AELs. If an image projector is to be assigned to RG3, the AE for UV, UV-A and IR shall be below the AEL for RG2 (see 6.1).

5 Risk group determination

5.1 Test conditions

The image projector shall meet the safety requirements defined in this part of IEC 62471 under all expected operating conditions appropriate to the intended use of the product. Factors to be considered shall include:

- climatic conditions (for example temperature, relative humidity);
- vibration and shock.

If no provisions are made in a specific product safety standard, the relevant subclauses of IEC 60950-1 and/or IEC 60065 shall apply.

The product shall be adjusted to achieve the maximum emission. The light source shall be operated at maximum optical power output. For image projectors this means that modulation, colour and spatial characteristics should be chosen to achieve the highest radiant power.

The evaluation shall include reasonably foreseeable single fault conditions such as failure of diffusers or light-beam processing optics prior to the projection lens or circuit failure. The accessible emission of the image projector shall not exceed the AEL of the assigned RG under any reasonably foreseeable single fault. The concepts of risk analysis should be applied to characterize if a given fault is reasonably foreseeable or not.

It is not mandatory to measure the accessible emission or the angular subtense of the apparent source (as parameter of the AEL). These parameters can also be determined by calculation, or they can be inferred from information provided by the lamp manufacturer (see 5.7). Also, depending on the type of light source, some accessible emission values (depending on associated wavelength range) need not be determined as specified in Table A.1.

5.2 Measurement conditions for image projectors

5.2.1 Measurement throw ratio

Fixed focal length projector systems that have no adjustable zoom shall be measured with the focus adjusted to achieve maximum radiance.

Projectors with an adjustable throw ratio (zoom) lens that is non-interchangeable shall be adjusted to achieve the highest ratio between the radiance and AEL.

Projectors with an interchangeable lens system shall be tested with the throw ratio adjusted to 2,0 or higher.

5.2.2 Measurement distance

The accessible emission shall be determined at a distance of 1,0 m from the closest point of human access toward the light source along the axis of the light beam (see Annex D).

5.3 The position and size of apparent source, the calculation of angular subtense

In this part of IEC 62471, the position of apparent source is defined as the location of the exit pupil of the projection lens.

The diameter is defined by using the 'Full Width at Half Maximum' (FWHM) (see Figure 4).

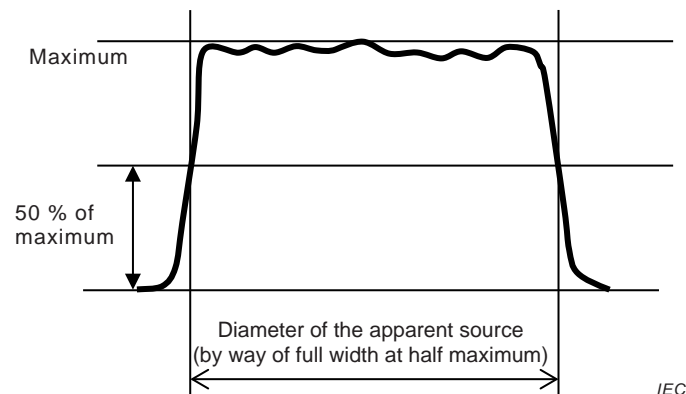

Figure 4 – Diameter of the apparent source

If the exit pupil is fully filled with an irradiance pattern (flashed), the outer diameters of the exit pupil can be used to determine the angular subtense α as seen from the measurement distance (see Annex C).

The AEL for the retinal thermal hazard depends on the parameter α , the angular subtense of the apparent source (see 3.4). The angular subtense of the apparent source is calculated by using the distance from the observer to the apparent source. If the radiance (AE to be compared with the retinal thermal AEL) is determined with an 11 mrad averaging angle of acceptance, then the minimum value of α for the determination of the AEL is 11 mrad. If the radiance is determined with an averaging angle of acceptance of 5 mrad (for instance for pulsed emission), the minimum value of α for the determination of AEL shall not be less than 5 mrad.

The angular subtense of an oblong source shall be determined by the arithmetic mean of the maximum and minimum angular dimensions of the source. For example, for a 20 mm long by 10 mm diameter tubular source at a viewing distance of $l = 1$ m in a direction normal to the lamp axis, it would be determined from the mean dimension, Z ;

$$Z = (20 + 10) / 2 = 15 \text{ mm (0,015 m)}.$$

Thus

$$\alpha = Z/l = 0,015 / 1 = 0,015 \text{ rad}.$$

Any angular dimension larger than α_{\max} shall be limited to α_{\max} and any angular dimension smaller than α_{\min} shall be limited to α_{\min} , prior to the determination of the arithmetic mean.

NOTE In this part of IEC 62471, the value for α_{\min} is 0,001 5 rad.

5.4 Measurement of irradiance – specified apertures

Where the limits in IEC 62471 are provided in irradiance or radiant exposure, the angle of acceptance values are specified in Table 1.

Measurements of irradiance shall be made to include localized areas of highest irradiance within the beam cross-section. On condition the irradiance profile in the beam for a white image can be assumed to be homogeneous (constant irradiance profile), the diameter of the aperture stop over which irradiance is averaged is not critical. A larger aperture stop can be used to improve the signal to noise ratio. Typical input optics diameters are 20 mm, but as long as a uniform irradiance profile is ensured aperture stop diameters up to 50 mm can be used.

5.5 Measurement of radiance

In cases where the limits are provided as radiance or radiance dose to be compared to AE that is spatially averaged radiance, the source radiance data shall be determined with projector focus and throw ratio setting as specified in 5.2.1. The field of view (averaging angle of acceptance of the radiance detector) is given in Table 1 for CW emission and in Table 2 for pulsed emission. The area of the source producing the maximum spatial radiance (hotspot) shall be determined.

Table 1 – Measurement criteria — field of view (angles of acceptance) for CW source

Hazard name	Wavelength range, nm	Angle of acceptance γ , rad		
		Exempt Group	Risk Group 1	Risk Group 2
UV	200 to 400	1,4	1,4	1,4
UV-A	315 to 400	1,4	1,4	1,4
Blue-light	300 to 700	0,11	0,011	0,011
Retinal thermal	380 to 1 400	0,011	0,011	0,011
Corneal/lens IR	780 to 3 000	1,4	1,4	1,4

Table 2 – Measurement criteria — field of view (angles of acceptance) for pulsed source

Hazard name	Wavelength range, nm	Angle of acceptance γ , rad		
		Exempt Group	Risk Group 1	Risk Group 2
UV	200 to 400	1,4	1,4	1,4
UV-A	315 to 400	1,4	1,4	1,4
Blue-light	300 to 700	0,11	0,011	0,011
Retinal thermal	380 to 1 400	0,005	0,005	0,005
Corneal/lens IR	780 to 3 000	1,4	1,4	1,4

5.6 Accessible emission limits

5.6.1 For CW emission

When the output is continuous for times greater than 0,25 s and the peak radiated power is not higher than 1,5 times the average radiated power, the pulse criteria defined in 5.6.2 need not be applied. In this case, the AE for the retinal thermal hazard is determined as average radiance (averaged over 0,25 s) and is compared with the CW-AEL for the retinal thermal hazard specified in Table 3 (see 3.7).

Table 3 – AEL (accessible emission limits) for risk groups of lamps and lamp systems emitting CW optical radiation

Hazard	Wavelength range, nm	Symbol for emission level ¹	Emission limits			Units
			Exempt Group	Risk Group 1	Risk Group 2	
UV ²	200 to 400	E_S	0,001	0,003	0,03	$W \cdot m^{-2}$
UV-A ²	315 to 400	E_{UVA}	10	33	100	$W \cdot m^{-2}$
Blue-light	300 to 700	L_B	100	10 000	4 000 000	$W \cdot m^{-2} \cdot sr^{-1}$
Blue-light small source	300 to 700	E_B	1,0	1,0	400	$W \cdot m^{-2}$
Retinal thermal	380 to 1 400	L_R	$28\,000/\alpha$	$28\,000/\alpha$	$28\,000/\alpha$	$W \cdot m^{-2} \cdot sr^{-1}$
IR anterior eye ²	780 to 3 000	E_{IR}	100	570	3200	$W \cdot m^{-2}$

¹ Symbols for emission levels (E_S , E_{UVA} , L_B , E_B , L_R , E_{IR}) and each formula are defined in IEC 62471. Some formulae of above emission levels are defined by using weighting functions $B(\lambda)$ and $R(\lambda)$ (see Table 8).

² For an image projector that is to be assigned to RG3, the AE for UV, UV-A and IR shall not exceed the AEL for RG2

Table 4 – Time base values associated with the risk groups and hazards

Hazard	Exempt Group	Risk Group 1	Risk Group 2
UV	30 000 s	10 000 s	1 000 s
UV-A	1 000 s	300 s	100 s
Retinal blue-light	10 000 s	100 s	0,25 s
Retinal thermal	0,25 s	0,25 s	0,25 s
Infrared cornea	1 000 s	100 s	10 s

Table 5 – Basic retinal thermal emission limit

Exposure duration t	Radiance L_R^{EL}	Unit
$t \leq 1 \mu s$	$0,63 \alpha^{-1} \cdot t^{-1}$	$W \cdot m^{-2} \cdot sr^{-1}$
$1 \mu s < t \leq 0,25 s$	$2,0 \times 10^4 \cdot \alpha^{-1} \cdot t^{-0,25}$	$W \cdot m^{-2} \cdot sr^{-1}$
$t > 0,25 s$	Determined as CW	

The angular subtense of the apparent source α is expressed in radians, and t is expressed in seconds.

The value of α in the determination of the AEL shall not be less than α_{min} and not be larger than α_{max} .

5.6.2 For pulsed emission

5.6.2.1 General

The emission should be considered to be pulsed if the peak radiated power is more than 1,5 times the average radiated power (see 3.28).

5.6.2.2 For UV, UV-A, photochemical retinal limits and IR cornea limits

Compare the averaged irradiance or averaged radiance with the AEL values of Table 3 (averaging over the time base associated with the risk group and respective limit, see Table 4).

5.6.2.3 For retinal thermal limit

For projectors emitting pulsed optical radiation, the classification criteria shall apply to the most restrictive of the requirements for a single pulse, or to any group of pulses.

The criteria below apply to the general case of pulsed emission.

In the general case, two criteria apply, and the respective accessible emission shall not exceed the AEL for either of the two criteria a) and b) as follows.

- a) Compare the averaged radiance with the AEL values of Table 5.
 - (a-1) For regularly emitted pulse trains (constant pulse parameters), average over the time base of 0,25 s.
 - (a-2) For irregular pulse patterns, average over emission durations that are shorter than or equal to 0,25 s in order to also analyse groups of pulses.
- b) Compare the peak radiance of each pulse with the AEL values of Table 5. The AEL values shall be multiplied by the factor C_5 in Table 6.

The pulse duration is defined as: $t_p = D/L_{\text{peak}}$ (see 3.27).

And the value of α used in the calculation of the AEL is defined in Table 6.

Table 6 – The values of C_5 and α for AEL calculation

Condition		Value of C_5	Value of α for calculating AEL
$\alpha \leq 0,005 \text{ rad}$		1,0	0,005 rad
$0,005 \text{ rad} < \alpha \leq \alpha_{\text{max}}$	$N \leq 40$	$N^{0,25}$	α
	$N > 40$	0,4	α
$\alpha_{\text{max}} < \alpha < 0,1 \text{ rad}$	$N \leq 625$	$N^{0,25}$	α_{max}
	$N > 625$	0,2	α_{max}
$\alpha \geq 0,1 \text{ rad}$		1,0	α_{max}

N is the number of pulses that occur within the time base.

α_{max} is defined in Table 7.

Table 7 – Pulse duration dependent values of α_{\max}

Emission duration	Maximum angular subtense α_{\max}
$t_p < 625 \mu\text{s}$	0,005 rad
$625 \mu\text{s} \leq t_p < 0,25 \text{ s}$	$0,2 t_p^{0,5}$ rad where t_p is given in seconds
$t_p \geq 0,25 \text{ s}$	0,1 rad

5.6.3 Spectral weighting functions

Spectral weighting functions for assessing thermal hazards are given in Table 8.

Spectral weighting functions for assessing ultraviolet hazards are given in IEC 62471.

Table 8 – Spectral weighting functions $B(\lambda)$ and $R(\lambda)$ for assessing retinal hazards

Wavelength nm	Blue-light hazard spectral weighting function $B(\lambda)$	Retinal thermal hazard spectral weighting function $R(\lambda)$
300 to 375	0,01	
380	0,01	0,01
385	0,013	0,013
390	0,025	0,025
395	0,05	0,05
400	0,10	0,10
405	0,20	0,20
410	0,40	0,40
415	0,80	0,80
420	0,90	0,90
425	0,95	0,95
430	0,98	0,98
435	1,0	1,0
440	1,0	1,0
445	0,97	1,0
450	0,94	1,0
455	0,90	1,0
460	0,80	1,0
465	0,70	1,0
470	0,62	1,0
475	0,55	1,0
480	0,45	1,0
485	0,40	1,0
490	0,22	1,0
495	0,16	1,0
500 to 600	$10^{[(450-\lambda)/50]}$	1,0
600 to 700	0,001	1,0
700 to 1050	–	$10^{[(700-\lambda)/500]}$
1050 to 1150	–	0,20
1150 to 1200	–	$0,2 \cdot 10^{0,02(1150-\lambda)}$
1200 to 1400	–	0,02

Representative wavelengths are shown: other values should be obtained by logarithmic interpolation at intermediate wavelengths

NOTE Tables 1, 2, 3, 4, 5, 6, 7 and 8 are from ICNIRP 2013 [1] and deviate from IEC 62471:2006.

5.7 Applying information from the lamp manufacturers

5.7.1 General

Under specific conditions, the assessment of a single lamp is directly transferable to the lamp system or luminaire. The risk group will remain the same, or may be reduced (by filters, etc.).

However, as a general rule for image projectors, the projection optics serve as a magnifier of the original light source; hence, the source size at the reference distance can be increased and irradiance in the beam, at the reference distance, will be increased. If the radiance of the lamp is determined as averaged over a given angle of acceptance and the lamp is smaller than that averaging angle of acceptance, then the averaged radiance for the projector will also be increased (the Law of Conservation of Radiance has to be used with caution).

5.7.2 Limits provided in irradiance/radiant exposure

In the spectral ranges 200 nm to 400 nm and 780 nm to 3 000 nm where the emission limits in IEC 62471 are provided in irradiance or radiant exposure, the measurements of an incorporated lamp cannot simply be transferred directly to the projector system, but require an analysis of the optical filtration and concentration by the projection optics to determine the system risk group.

Additional optics modify the radiance of a source, (i.e. may have a significant impact) where the classification is based on irradiance or radiant exposure criteria.

5.7.3 Limits provided in radiance or radiance dose

In cases where the emission limits in IEC 62471 are provided in terms of spatially averaged radiance or spatially averaged radiance dose, the Law of Conservation of Radiance has to be used with caution. That is, if the true source radiance of a light source (arc lamp, single LED, etc.) is below the radiance level specified (per risk group), the final lamp system (or LED-array) also cannot exceed the accessible emission limits. True source radiance can be reduced by apertures and transmission losses but not increased over that of the bare lamp. IEC 62471 requires measurements of spatially averaged radiance (see 3.32) values with the consequence that the relationship between the field of view and the source area, as it was used for the characterization of a single component, may be changed by the projection optics. Consequently, if the lamp is smaller than the averaging angle of acceptance (field of view), or if it has radiance hotspots, the averaged radiance as determined for the lamp can be significantly increased due to the projection optics.

6 Manufacturer's requirements

6.1 General

The primary purpose of projector risk-group classification by the manufacturer is to determine the need for any engineering controls and to inform the user of potential hazards that may require precautions or limitations on installation. Therefore, when a projector is determined to be Risk Group 1, 2 or 3, it is important that the user is informed by labelling and user manual data, regarding which potential hazards may require controls.

The risk group of the image projector shall be determined according to Clause 5.

Projectors which are RG2 or lower may become RG3 when fitted with interchangeable lenses with larger throw ratios. These lenses shall include user information (see 6.7.5).

Risk Group 1 and Exempt Group projectors do not require controls, since it is not reasonably foreseeable that the emission of image projectors will be directed into the eyes of people for extended periods of time (hours).

RG3 products are intended for professional use only, and are not intended for consumer use.

The products shall be designed not to emit unnecessary optical radiation outside of the 380 nm to 780 nm wavelength range. For image projectors that are assigned to RG3, the AE for UV, UV-A and IR shall be below the AEL for RG2.

The products shall be designed for foreseeable variations of installation conditions (the possibility of installation on the ceiling, in a vehicle, etc.).

6.2 Determination of HD (hazard distance)

For RG3 products, the HD shall be determined under maximum emission power at each throw ratio.

For interchangeable lenses, the maximum foreseeable HD should be provided.

The basis of the HD is the AEL for the retinal thermal hazard with assumed exposure duration of 0,25 s (see Table 3 and Table 5). The value of α is to be in units of radians. See Annex E for additional information.

6.3 Safety feature "soft start"

The initial emission from RG2 and RG3 projectors after power on shall be controlled so that the full power emission start no sooner than one full second after light is first emitted from the lens.

NOTE "The full power emission" includes any partial irradiance of the projection area.

6.4 Optional safety features

6.4.1 Projection of warning message

Risk of potential hazardous exposure can be reduced during system start up with the use of visible or audible signals. Additionally, warning text and/or graphics may be projected on to the screen. Projected warning may include text such as 'Do not stare into beam'. Indicating the hazard distance may also be useful guidance to the user.

EXAMPLE "Do not directly expose eyes to projected light closer than <insert HD> from projector lens"

6.4.2 Power reduction by sensor system

Sensors which detect the location of the human body or objects within hazardous areas are used widely in factory automation fields. If such devices have a sufficiently high reliability level and the output power is reduced automatically when personnel or reflective objects enter the hazardous area, such a protective system can be considered effective for reducing the risk of hazardous light exposure.

6.5 Labelling on products

6.5.1 General

Each product shall carry label(s) in accordance with the requirements of the corresponding clauses in the following, depending on the projector risk group classification.

- The labels shall be durable, permanently affixed, legible, and clearly visible during operation, maintenance or service, according to their purpose.
- They should be positioned so that they can be read without the necessity for human exposure to optical radiation in excess of the applicable AEL.
- The label and symbol size should be adapted to the size of the product.
- For the RG2 label (Figure 6), RG3 label (Figure 9) and the optical radiation warning symbol (Figure 10), text and borders shall be black on a yellow background.

If the projector incorporates lasers (laser illuminated projectors), the appropriate label required by IEC 60825-1:2014, 4.4 shall also be carried.

NOTE Projectors containing an enclosed laser system and whose accessible radiance during normal operation is below the threshold specified in IEC 60825-1:2014 are exempted from the laser product classification and its associated classification labelling for the projector light. Such laser product labelling applies only to accessible laser emissions except for the projector light. Hence the laser product label would be typically Class 1 or in a few instances, Class 2. Labelling in accordance with this part of IEC 62471 applies to the projector light.

Reproductions of all required labels should be included in the user manual.

Projectors which are RG2 or lower as evaluated under the throw ratio method in this part of IEC 62471, which may become RG3 when fitted with interchangeable lenses with larger throw ratios, shall include additional labelling (see 6.6).

Explanations of each label according to each risk group are shown in Table 9.

Table 9 – Labelling on products

RG0	RG1	RG2	RG3
Not required	Not required [Optional] • RG1 label in Figure 5.	<ul style="list-style-type: none"> • Caution label in Figure 6. or • RG2 caution symbol in Figure 7. or • RG2 caution pictogram in Figure 8 or a similar design. 	<ul style="list-style-type: none"> • Warning label in Figure 9. • Optical radiation warning symbol in Figure 10. • "Not for household use" symbol in Figure 11.

6.5.2 RG0 projector

RG0 projector is safe for general use.

Projector products require no additional labelling.

6.5.3 RG1 projector

An optional label indicates "RG1" can be applied on the product (see Figure 5).



IEC

Figure 5 – RG1 label (optional)

6.5.4 RG2 projector

A label shall be applied on the product similar to:

“Caution Do not stare into the beam, RG2” (see Figure 6).

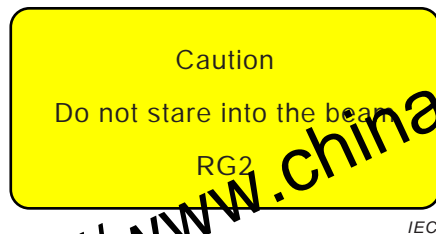

Figure 6 – RG2 label

Alternatively,

- the RG2 caution symbol (Figure 7) may be used, comprising symbol IEC 60417-6069 (2011-08) with the addition of the text "RG2", or
- the RG2 caution pictogram (Figure 8) or a similar design may be used with the addition of the text "RG2".

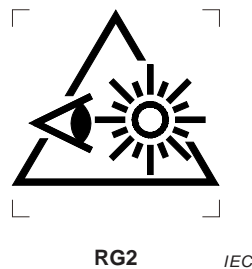

Figure 7 – RG2 caution symbol

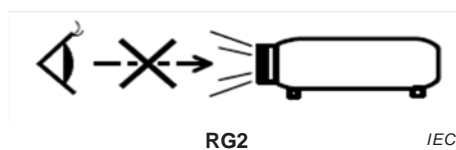

Figure 8 – Sample design of RG2 caution pictogram

The RG2 caution symbol should be placed close to the aperture. Direct printing or engraving on the product is acceptable.

6.5.5 RG3 projector

A label shall be applied on the product similar to:

“Warning! Do not look into the beam. No direct eye exposure to the beam is permitted, RG3. Hazard Distance: Refer to the manual” (see Figure 9).



Figure 9 – RG3 label

RG3 projectors shall also have the optical radiation warning symbol [ISO 7010-W027 (2011-05), see Figure 10] and the "Not for household use" symbol [IEC 60417-5109 (2002-10), see Figure 11].



Figure 10 – Optical radiation warning symbol

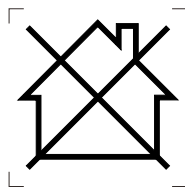

Figure 11 – "Not for household use" symbol

6.6 User information

6.6.1 General

Manufacturers shall provide adequate user information according to the risk group of the product.

The user information shall include the risk group classification of the projector, any required precautions and hazard distance for RG3 product if applicable. The risk group shall be described in the user manual with the name and the edition of this standard.

Normal intended use and safety instructions shall be described in detail. If required, training and installation requirements (e.g. restricted area requirements) shall be specified in the user manual.

NOTE National legislation regarding occupational safety and health (OSH) and/or event safety may contain additional or different requirements.

The manufacturer shall provide information on how the hazard distance may change for different optical features (i.e. zooming feature, interchangeable lens system) for RG3 products.

If an interchangeable lens system can be used on the projector, all possible reasonably foreseeable worst-case hazard distances shall be listed for the appropriate range of modifying optics in the user manual (see 6.7). These values could be displayed in one graph or table and could be based on calculations (see Annex E).

Explanations of specified information according to each risk group are shown in Table 10.

6.6.2 Assessment of user accessible area

A label or symbol is sufficient to warn against staring into the product from close distances.

However, an RG3 system has an associated hazard distance for momentary direct viewing (assumed exposure duration of 0,25 s) of greater than 1 m. The person who is in the accessible area within the hazard distance should be protected from this potential viewing hazard. In addition to warning labels, further requirements for RG3 projectors to avoid such a risk are then needed.

The requirements for user safety in the accessible area of an RG3 system are defined in 6.6.3.5.

6.6.3 User information (user manual)

6.6.3.1 General

Table 10 – User information in user manual

RG1	RG2	RG3
<ul style="list-style-type: none"> "RG1 IEC 62471-5:2015" 	<ul style="list-style-type: none"> "As with any bright source, do not stare into the direct beam, RG2 IEC 62471-5:2015" Reproductions of all required labels 	<ul style="list-style-type: none"> "No direct exposure to the beam shall be permitted, RG3 IEC 62471-5:2015" Hazard distance "Operators shall control access to the beam within the hazard distance or install the product at the height that will prevent exposures of spectators' eyes within the hazard distance" Reproductions of all required labels

6.6.3.2 RG0 projector

RG0 projectors are safe for general use.

Projector products require no special information.

6.6.3.3 RG1 projector

User manuals and product information shall state "RG1 IEC 62471-5:2015".

6.6.3.4 RG2 projector

User manuals and product information shall state the following text, or equivalent:

"As with any bright light source, do not stare into the beam, RG2 IEC 62471-5:2015"

6.6.3.5 RG3 projector

The risk group and the hazard information including HD according to the throw ratio shall be provided.

User information shall indicate that the user must understand the risk and apply protective measures based upon the hazard distance as indicated on the label and in the user information. Installation method, barriers, detection system or other applicable control measure shall prevent hazardous eye access to the radiation within the hazard distance.

For example, cinema projectors that have a HD greater than 1 m and emit light into an uncontrolled area where persons may be present should be positioned in accordance with "the fixed projector installation" parameters, resulting in a HD that does not extend into the audience area unless the beam is at least 2 m above the floor level. In non-cinema environments where unrestrained behaviour is reasonably foreseeable, the minimum separation height should be greater than or equal to 3,0 m to prevent potential exposure, for example by an individual sitting on another individual's shoulders, within the HD. For example, a sufficiently large separation height may be achieved by mounting the image projector on the ceiling or through the use of physical barriers.

User manuals and product information shall state the following text, or equivalent:

- "No direct exposure to the beam shall be permitted, RG3 IEC 62471-5:2015".
- "Operators shall control access to the beam within the hazard distance or install the product at the height that will prevent spectators' eyes from being in the hazard distance".

6.6.4 User information for maintenance

The instructions for the replacement of lamps shall clearly state risks and proper procedures. In the case of maintenance of the RG3 projector, only authorized trained service personnel for RG3 products shall perform these tasks.

Advice on safe operating procedures and warnings concerning reasonably foreseeable misuse, malfunctions and hazardous failure modes shall be given in the user manual. Where maintenance procedures are detailed, they shall include explicit instructions on safe practices.

6.7 Labelling and user information for image projectors where the risk group will be changed by interchangeable lens

6.7.1 General

If the projector incorporates a removable 'modifying optics system' (projection lens), HD information according to the optical specifications of the lens shall be stated.

As the risk group determination for removable optics is performed for a throw ratio (TR) of 2,0, lenses with TR higher than 2,0 can potentially create a HD that exceeds 1 m. If there are removable modifying optics that have a TR higher than 2,0 that can be used with the product, and if a higher TR leads to a HD longer than 1 m (see also Annex E), the following labels as specified in 6.7.2 shall be provided on the product and also contained in the user manual.

Projectors that change to Risk Group 3 are intended for professional use only, and are not intended for consumer use.

6.7.2 Labelling on the projector

Along with the standard RG label (as for RG2, the caution message is provided), the following message or similar shall be included on the same label:

"This projector may become RG3 when an interchangeable lens with throw ratio greater than xxx (unique value for each projector) is installed. Refer to the manual for the lens list and hazard distance before operation. Such combinations of projector and lens are intended for professional use only, and are not intended for consumer use."

Even if the original RG is RG1 or RG0, this warning shall be provided as a label.

The label is selectable from Figure 12, Figure 13 or Figure 14;

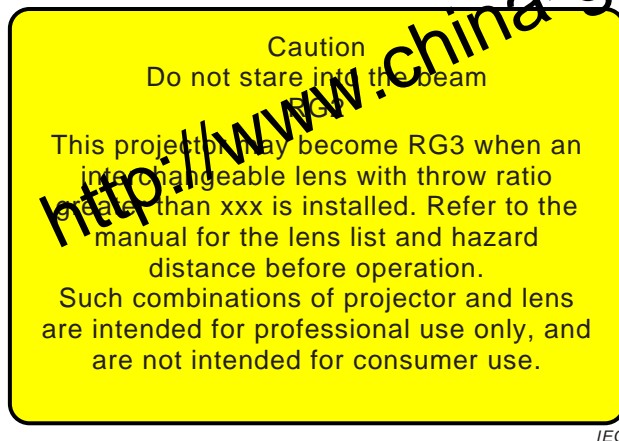

Figure 12 – RG2 label with the caution for RG3

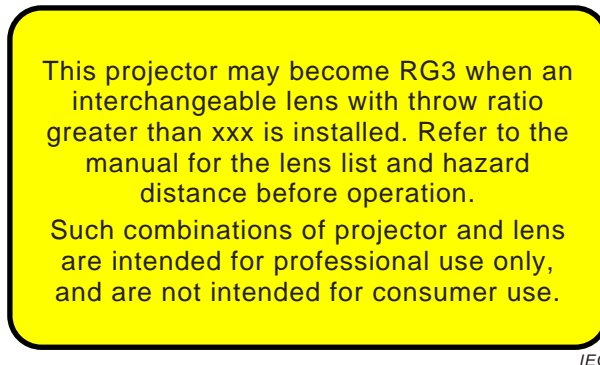
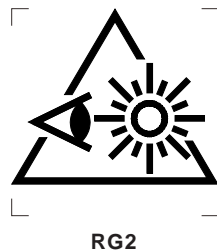

Figure 13 – RG2 caution label with the caution for RG3

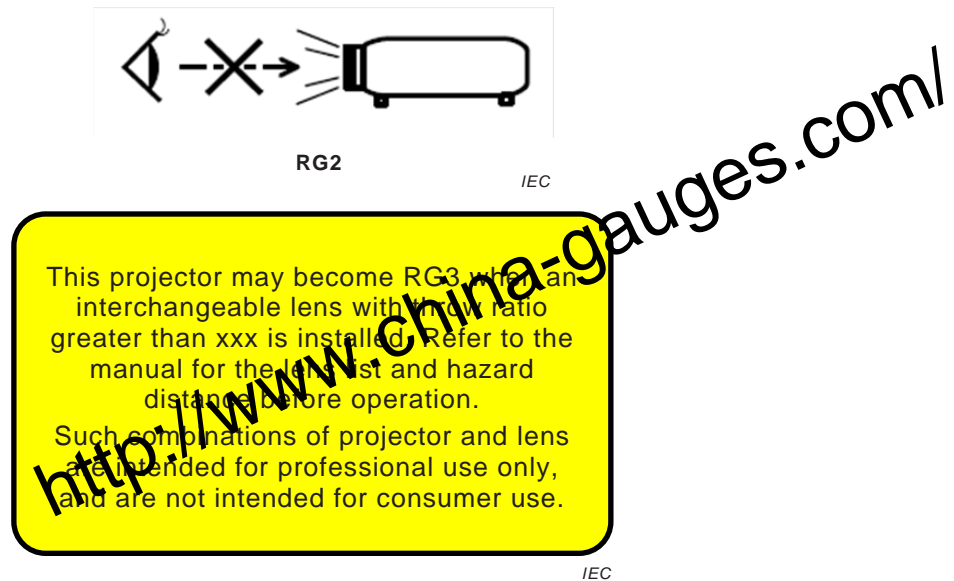

Figure 14 – RG2 pictogram with the caution for RG3

6.7.3 Mark on the interchangeable lens

“Throw Ratio Range” or “Model Number” shall be marked with their relevant parameter value on interchangeable lenses so that the user can identify the parameter name and value from the outside even after installation.

Direct printing or engraving on the product is acceptable.

When the mark is not displayed, the manufacturer shall design the projector so that it displays, on the screen, the information about the hazard mentioned in 6.7.2. That information shall be provided at the beginning of the projection by emissions below the RG3 level until it is ended by manual operation.

6.7.4 The user information in the user manual of the projector

The information shall include:

- The explanation of the change of hazard magnitude by installing interchangeable lenses. The explanation shall include the warning of RG3 projectors as follows similar to:
 - “No direct exposure to the beam shall be permitted”
 - “Operators shall control access to the beam within the hazard distance or install the product at a height that will prevent eye exposure within the hazard distance”.
- The list of model numbers (or model names) of interchangeable lenses for the projector.
- The hazard distance at the maximum TR of each lens when installed on the projector. The manufacturer should select an easily understandable method of informing users, such as tabular or graphical information.

6.7.5 The user information in the user manual of the interchangeable lens

The information shall include:

- An explanation of the change of hazard by installing the lens. The explanation shall include the RG3 warning as follows similar to:
 - “No direct exposure to the beam shall be permitted”

“Operators shall control access to the beam within the hazard distance or install the product at a height that will prevent eye exposure within the hazard distance”.

- The throw ratio range of the lens.
- The list of model numbers (or model names) of projectors with which the lens may be used.
- The hazard distance according to the highest TR for typical models. The manufacturers should select an easily understandable method of informing users, such as tabular or graphical information.

7 Information for service

Potential hazards may exist during lamp or product servicing.

In addition to the requirements of user information for maintenance (6.6.4), the manufacturer shall provide information sufficient for safety training of servicing personnel.

Laser-illuminated projectors – although generally Class 1 laser products during operation – usually contain Class 3B or Class 4 embedded lasers. Service shall be performed only by authorized, trained servicing personnel (IEC 60825-1; IEC TR 60825-14 [3]).

Annex A
(normative)

Test scheme for lamp types

Table A.1 –Required evaluations

Lamp Type	E_s	E_{UVA}	L_B/E_B	E_{IR}
LED	Not required ²	Not required ²	Required	Not required
Tungsten-halogen	Not required ¹	Not required ¹	Required	Required
Discharge or arc-lamp	Not required ¹	Not required	Required	Required
Laser generated	Not required ¹	Not required ²	Required	Required

¹ Not required unless UV transmissive projection optics are installed.
² Not required unless phosphor conversion originated from a UV source.
 Low visual stimulus evaluation is not required.

Annex B (informative)

Example of calculations

B.1 Radiance calculations

B.1.1 General

The radiance L ($\text{W}\cdot\text{m}^{-2}\cdot\text{sr}^{-1}$) is determined (see, for example, Figure B.1) by measuring the radiant power P (W) passing through a defined measurement aperture stop and field stop, at a defined measurement distance l .

The diameter d of the aperture defines the solid collection angle Ω (sr) and the measurement area A_{FOV} (herein defined as the area under the “field of view”, in m^2) corresponds to the acceptance angle (γ) predetermined by the circular field stop in front of the detector.

$$L (\text{W}\cdot\text{m}^{-2}\cdot\text{sr}^{-1}) = P (\text{W}) / (\Omega (\text{sr}) A_{\text{FOV}} (\text{m}^2)),$$

which can also be expressed as

$$L = E/\Omega \tag{B.1}$$

where

E is the irradiance on a detector placed at 1 m from the projector; and

Ω is the solid-angular subtense of the projected source.

For retinal thermal hazard:

$$\begin{aligned} \gamma (\text{angle of acceptance}) &= 11 \text{ mrad} && \text{for CW source} \\ &= 5 \text{ mrad} && \text{for pulsed wave source} \end{aligned}$$

The zoom position of projection lenses shall be adjusted so as to achieve maximum radiance (the longest throw ratio in general).

Projectors with an interchangeable lens system shall be tested with the throw ratio of the lenses adjusted to 2,0 or higher.

B.1.2 Calculation from measured irradiance

For example, consider a measured irradiance of $0,7 \text{ W}\cdot\text{m}^{-2}$ at 1 m from a data projector, and a measured source size of 1,8 mrad by 2,2 mrad.

Assumes:

The optical emission is CW from a homogeneous source.

The source size solid-angular subtense then is:

$$\Omega = 0,0018 \times 0,0022 = 4,0 \times 10^{-6} \text{ sr} .$$

Thus:

$$L = 0,7 / (4,0 \times 10^{-6}) = 1,8 \times 10^5 \text{ W}\cdot\text{m}^{-2}\cdot\text{sr}^{-1} .$$

Since radiance is a radiometric invariant, it can be measured at the source, along the beam path, or at the detector. In some cases where apertures are filled uniformly with radiation, the radiance can also be estimated from the output specifications (or luminance L_V) instead of irradiance as in the above example. The luminance can be derived from output lumens and beam divergence angle of the projector.

B.1.3 Calculation from luminous output

For example, a theatre projector with a 25 000 lm output, a beam diameter of 4,0 cm at the exit point from the projection optics, and with a large beam spread of about 14,3° high by 28,6° wide (250 mrad by 500 mrad) will produce a beam with an associated solid angle

$$\Omega = 0,25 \times 0,5 = 0,125 \text{ sr} .$$

Hence the approximate radiance can be estimated by employing the cross-sectional area A_S :

$$A_S = \pi (0,04 / 2)^2 = 12,6 \times 10^{-4} \text{ m}^2 .$$

And the luminous exitance M_V would therefore be

$$M_V = 25\,000 / 12,6 \times 10^{-4} = 1,98 \times 10^7 \text{ lm} \cdot \text{m}^{-2} .$$

Therefore,

$$L_V = M_V / \Omega = 1,98 \times 10^7 / 0,125 = 1,59 \times 10^8 \text{ cd} \cdot \text{m}^{-2} .$$

For a luminous efficacy of radiation $k = 160 \text{ lm/W}$, photometric luminance is converted to radiometric radiance as

$$L_e = L_V / k = (1,59 \times 10^8) / 160 = 9,9 \times 10^5 \text{ W} \cdot \text{m}^{-2} \cdot \text{sr}^{-1} .$$

k is calculated from the spectrum as follows:

$$k = 683 \cdot \int V(\lambda) \Phi(\lambda) d\lambda / \int \Phi(\lambda) d\lambda ,$$

where

$V(\lambda)$ is the spectral luminous efficiency in photopic vision; and

$\Phi(\lambda)$ is the spectral power distribution of the output light.

NOTE This only applies for fully uniform filled apertures.

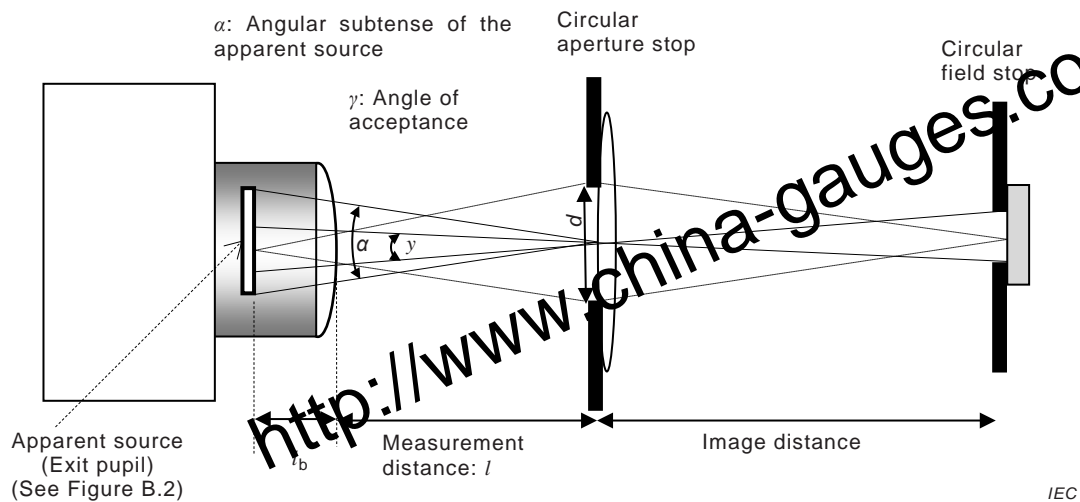

Figure B.1 – Image of the apparent source and measurement condition

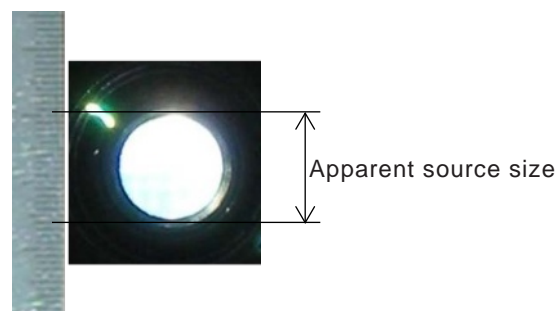

Figure B.2 – Picture of the apparent source of a projector at the exit pupil of the projection lenses with a scale

B.2 Calculation example of risk group (CW)

B.2.1 Example of a 5 000 lm projector

The lenses are interchangeable.

The maximum throw ratio of one lens model (N_{TR}) is 2,0.

The aspect ratio N_{AS} is 0,75 (Horizontal:Vertical = 4:3).

The apparent source size of a projector is 20 mm in diameter where $N_{TR} = 2,0$.

The distance l_b between the outer surface of the lens and the exit pupil is $l_b = 10$ cm.

Assumes:

The spectral weighting functions are 1,0 for visible wavelength.

The luminous efficacy of radiation is 300 lm/W.

The optical emission is CW from a homogeneous source.

Angular subtense α of the source at a measurement distance of 1 m is

$$\alpha = 0,02 / (1 + 0,1) = 0,018 \text{ rad} .$$

The angular subtense α is 18 mrad and the solid angle subtended by α is

$$\Omega = \pi (0,018)^2 / 4 = 2,60 \times 10^{-4} \text{ sr} .$$

The width of the projection area at a measurement distance of 1 m is

$$(1 + 0,1) / 2,0 = 0,55 \text{ m} (N_{\text{TR}} = 2,0) .$$

The height of the projection area is

$$0,550 \text{ m} \times 0,75 = 0,413 \text{ m} .$$

Therefore, illumination area is

$$0,550 \text{ m} \times 0,413 \text{ m} .$$

The radiant power P (W) passing through the above illumination area is

$$P = 5\,000 / 300 = 16,7 \text{ W} .$$

The irradiance E at 1 m distance from the outer surface of the lens is then

$$E = 16,7 / (0,55 \times 0,41) = 73,5 \text{ W}\cdot\text{m}^{-2} .$$

Therefore,

$$L = E/\Omega = 73,6 / (2,54 \times 10^{-4}) = 2,83 \times 10^5 \text{ W}\cdot\text{m}^{-2}\cdot\text{sr}^{-1} .$$

- Retinal thermal hazard

The emission limit of retinal thermal hazard L_R is obtained from Table 3.

$$L_R \text{ for RG2} = 28\,000/\alpha = 1,54 \times 10^6 \text{ W}\cdot\text{m}^{-2}\cdot\text{sr}^{-1};$$

L is smaller than L_R .

- Blue-light hazard

The emission limit of blue light hazard L_B is obtained from Table 3.

$$L_B \text{ for RG2} = 4\,000\,000 \text{ W}\cdot\text{m}^{-2}\cdot\text{sr}^{-1};$$

$$L_B \text{ for RG1} = 10\,000 \text{ W}\cdot\text{m}^{-2}\cdot\text{sr}^{-1}.$$

Because L_B (L_{Average} of blue-light hazard) is calculated by using $B(\lambda)$ (see Table 8), it is obviously lower than L_{Average} of retinal thermal hazard using $R(\lambda)$.

In this example, L_{Average} of retinal thermal hazard is lower than AEL of blue-light hazard for RG2.

Therefore, the blue-light hazard of the emission is RG2 or lower.

Therefore the projector is classified as RG2 if other hazard elements do not exceed each emission limit for RG2.

B.2.2 10 000 lm professional-use projector with an apparent source of small subtense angle (CW)

The lenses are fixed.

The maximum throw ratio N_{TR} is 5,0

The aspect ratio N_{AS} is 0,75 (Horizontal:Vertical = 4:3).

The apparent source size of a projector is 30 mm in diameter where $N_{TR} = 5,0$.

The distance between the outer surface of the lens and the aperture; $l_b = 18$ cm.

Assumes:

The spectral weighting functions are 1,0 for visible wavelength.

The luminous efficacy of radiation is 300 lm/W.

The optical emission is CW from a homogeneous source.

Angular subtense α of the source at a measurement distance of 1 m is

$$\alpha = 0,03 / (0,18 + 1,0) = 0,025 \text{ rad} .$$

The angular subtense α is 0,025 rad and the solid angle subtended by α is

$$\Omega = \pi (0,025)^2 / 4 = 5,08 \times 10^{-4} \text{ sr} .$$

Illumination area is

$$0,236 \text{ m} \times 0,177 \text{ m} \text{ at } 1,18 \text{ m} \text{ from the aperture of the projector } (N_{TR} = 5,0).$$

The radiant power $P(W)$ passing through the above illumination area is

$$P = 10\,000 / 300 = 33,3 \text{ W} .$$

The irradiance E at 1 m distance from the outer surface of the lens is then

$$E = 33,3 / (0,24 \times 0,18) = 798 \text{ W}\cdot\text{m}^{-2} .$$

Therefore,

$$L = E/\Omega = 798 / (4,9 \times 10^{-4}) = 1,57 \times 10^6 \text{ W}\cdot\text{m}^{-2}\cdot\text{sr}^{-1} .$$

- Retinal thermal hazard

The emission limit of retinal thermal hazard L_R is obtained from Table 3.

$$L_R \text{ for RG2} = 28\,000/\alpha = 1,10 \times 10^6 \text{ W}\cdot\text{m}^{-2}\cdot\text{sr}^{-1};$$

L is greater than L_R .

Therefore the projector is classified as RG3.

When radiance exceeds the RG2 limit, the HD is the distance where the exposure level is equal to the exposure limit for retinal thermal injury for an exposure duration of 0,25 s.

- Calculation of hazard distance (HD)

$$L = E / \Omega;$$

$E = P / S$ where S is projection area;

$$S = (l / N_{TR}) N_{AS} (l / N_{TR});$$

$$\Omega = \pi \alpha^2 / 4.$$

Assume: the apparent source size of a projector d_S is not changed at the position of HD,

$$\Omega = \pi d_S^2 / 4l^2$$

$$L = 4 \cdot P \cdot N_{TR}^2 / (N_{AS} \pi \cdot d_S^2)$$

$$L_R \text{ for RG2} = 28\,000/\alpha = 28\,000 \, l_{HD} / d_S$$

where

l_{HD} is the distance between the source and the RG2 position:

$$l_{HD} = 4 P N_{TR}^2 / (28\,000 N_{AS} \pi \cdot d_S)$$

$$P = 33,3$$

$$N_{TR} = 5,0$$

$$N_{AS} = 0,75$$

$$d_S = 0,03$$

$$l_{HD} = 1,68 \text{ (m)}$$

$$HD = 1,68 - 0,18 = 1,5 \text{ (m)}$$

B.2.3 2 000 lm projector with small apparent source (CW)

The lenses are fixed.

The maximum throw ratio is 0,8.

The aspect ratio (Horizontal:Vertical) is 4:3.

The apparent source size of a projector is 4,0 mm in diameter where TR = 0,8.

The distance l_b between the outer surface of the lens and the exit pupil is $l_b = 3,0$ cm.

Assumes:

The spectral weighting functions are 1,0 for visible wavelength.

The luminous efficacy of radiation is 300 lm/W.

The optical emission is CW from a homogeneous source.

Angular subtense α of the source at a measurement distance of 1 m is

$$\alpha = 0,004 / (0,03 + 1,0) = 3,9 \times 10^{-3} \text{ rad} .$$

The angular subtense α is 3,9 mrad and the solid angle subtended by α is

$$\Omega = \pi (0,0039)^2 / 4 = 1,2 \times 10^{-5} \text{ sr} .$$

Illumination area is 1,29 m × 0,966 m at 1,03 m from the aperture of the projector (TR = 0,8).

The radiant power P (W) passing through the above illumination area is

$$P = 2\,000 / 300 = 6,67 \text{ W} .$$

The irradiance E at 1 m distance from the outer surface of the lens is then

$$E = 6,67 / (1,29 \times 0,966) = 5,36 \text{ W}\cdot\text{m}^{-2} .$$

Therefore,

$$L = E/\Omega = 5,36 / 1,2 \times 10^{-5} = 4,53 \times 10^5 \text{ W}\cdot\text{m}^{-2}\cdot\text{sr}^{-1} .$$

- Retinal thermal hazard

The emission limit of retinal thermal hazard L_R is obtained from Table 3.

$$L_R \text{ for RG2} = 28\,000/\alpha = 28\,000 / (3,88 \times 10^{-3}) = 7,21 \times 10^6 \text{ W}\cdot\text{m}^{-2}\cdot\text{sr}^{-1} .$$

The angular subtense α is 3,9 mrad.

As a result, L is smaller than L_R .

- Blue-light hazard

The emission limit of blue-light hazard L_B is obtained from Table 3.

$$L_B \text{ for RG2} = 4\,000\,000 \text{ W}\cdot\text{m}^{-2}\cdot\text{sr}^{-1};$$

$$L_B \text{ for RG1} = 10\,000 \text{ W}\cdot\text{m}^{-2}\cdot\text{sr}^{-1}.$$

L_{Average} of retinal thermal hazard is lower than AEL of blue-light hazard for RG2.

Therefore, the blue light hazard of the emission is RG2 or lower (see B.1.4).

Therefore the projector is classified as RG2 if other hazard elements do not exceed each emission limit for RG2.

B.3 Calculation example of risk group (pulsed emission)

B.3.1 General

The pulsed emission is defined by 3.27 (pulse duration) and 3.28 (pulsed emission).

If the emission of the projector is categorized as pulsed emission, the AEL for retinal thermal is calculated and risk group is determined as follows (see 5.6.2.3).

- Compare the averaged irradiance or averaged radiance with the AEL values of Table 3.
- The peak radiance shall be compared to the emission limit (AEL) in Table 5. The AEL values shall be multiplied by the factor C_5 in Table 6.

t_p : pulse duration, $t_p = D/L_{\text{peak}}$

D : radiance dose

L_{peak} : peak radiance

α used in the calculation of AEL is defined in Table 6.

B.3.2 14 000 lm projector with one peak

See Figure B.3.

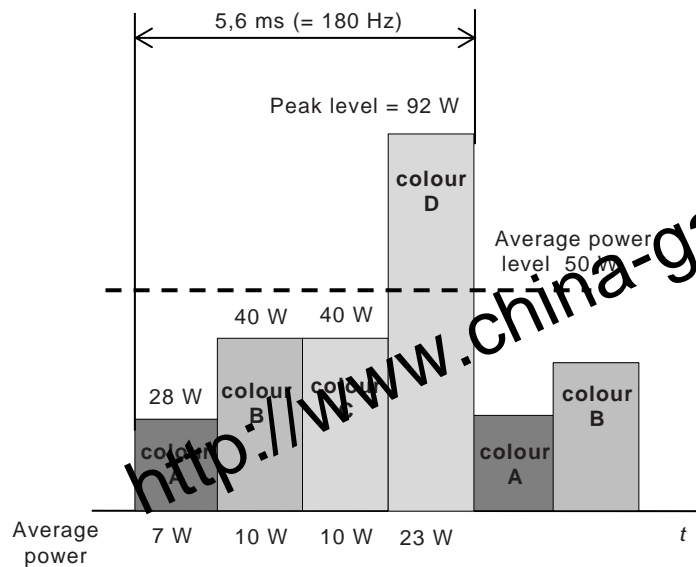

IEC

Figure B.3 – Example with one peak of pulsed emission

The lenses are fixed.

The maximum throw ratio is 2,0.

The aspect ratio (Horizontal:Vertical) is 4:3.

The apparent source size of a projector is 20 mm in diameter where $TR = 2,0$.

The distance l_b between the outer surface of the lens and the exit pupil is $l_b = 15,0$ cm.

Assumes:

The spectral weighting functions are 1,0 for visible wavelength.

The luminous efficacy of radiation is 280 lm/W.

The optical emission is pulsed emission from a homogeneous source.

Angular subtense α of the source at a measurement distance of 1 m is

$$\alpha = 0,020 / (0,15 + 1,0) = 1,74 \times 10^{-2} \text{ rad} .$$

Illumination area is 0,575 m \times 0,431 m at 1,15 m from the aperture of the projector ($TR = 2,0$).

The average radiant power P (W) passing through the above illumination area is

$$P = 14\,000 / 280 = 50,0 \text{ W} .$$

The average irradiance E at 1 m distance from the outer surface of the lens is then

$$E = 50,0 / (0,575 \times 0,431) = 202 \text{ W}\cdot\text{m}^{-2} .$$

The angular subtense α is 17,4 mrad and the solid angle is

$$\Omega = \pi (0,0174)^2 / 4 = 2,38 \times 10^{-4} \text{ sr} .$$

Therefore,

average radiance is

$$L_{\text{Average}} = E/\Omega = 202 / (2,38 \times 10^{-4}) = 8,49 \times 10^5 \text{ W}\cdot\text{m}^{-2}\cdot\text{sr}^{-1} .$$

- Evaluation of retinal thermal hazard

1) Comparison of the average radiance with the CW AEL

$$L_{\text{Average}} = E/\Omega = 8,49 \times 10^5 \text{ W}\cdot\text{m}^{-2}\cdot\text{sr}^{-1} .$$

The exposure duration time t is

$$t = 0,25 \text{ s} .$$

From Table 6 and Table 7, the maximum angular subtense α_{max} is

$$\alpha_{\text{max}} = 0,2 t^{0,5} = 0,1 \text{ rad} .$$

$$\alpha < \alpha_{\text{max}}$$

Therefore, α is selected for the calculation of AEL.

$$\text{AEL} = 2,0 \times 10^4 \times 0,25^{-0,25} \times (1,74 \times 10^{-2})^{-1} = 1,63 \times 10^6 \text{ W}\cdot\text{m}^{-2}\cdot\text{sr}^{-1} .$$

Therefore,

averaged radiance < AEL

2) Comparison of the pulse energy and AEL of multiple pulse emissions

Calculate for the total radiance dose D of one cycle:

$$D = L_{\text{Average}} 1/180 = (8,49 \times 10^5) / 180 = 4,72 \times 10^3 \text{ J}\cdot\text{m}^{-2}\cdot\text{sr}^{-1} .$$

Calculate for the combination of peak radiance:

$$L_{\text{peak}} = L_{\text{Average}} 92 / 50 = 1,56 \times 10^6 \text{ W}\cdot\text{m}^{-2}\cdot\text{sr}^{-1} .$$

- The calculation of AEL

The pulse duration is

$$t_p = D/L_{\text{peak}} = (4,72 \times 10^3) / (1,56 \times 10^6) = 3,02 \times 10^{-3} \text{ s} .$$

From Table 6 and Table 7, the maximum angular subtense α_{max} is

$$\alpha_{\text{max}} = 0,2 t^{0,5} \text{ rad} = 0,2 \times (3,01 \times 10^{-3})^{0,5} = 11 \times 10^{-3} \text{ rad} .$$

$$\alpha_{\text{max}} < \alpha$$

Therefore, α_{max} is selected for the calculation of AEL.

- The calculation of C_5

N (the number of pulses that occurs within the time base) is

$$N = 180 \times 0,25 = 45 .$$

For $\alpha_{\max} < \alpha < 100$ mrad, for $N \leq 625$,

$$C_5 = N^{-0,25} = 0,39 .$$

The emission limit of retinal thermal hazard (AEL) is obtained from Table 5.

$$\text{AEL} = 2,0 \times 10^4 \times (3,02 \times 10^{-3})^{-0,25} \times 0,39 \times (11,0 \times 10^{-3})^{-1} = 3,0 \times 10^6 \text{ W}\cdot\text{m}^{-2}\cdot\text{sr}^{-1} .$$

Peak radiance (L_{peak}) of [colour D] is less than AEL of multiple pulse emissions.

- Evaluation of blue-light hazard

The emission limit of blue-light hazard L_B is obtained from Table 3.

$$L_B \text{ for RG2} = 4\,000\,000 \text{ W}\cdot\text{m}^{-2}\cdot\text{sr}^{-1};$$

$$L_B \text{ for RG1} = 10\,000 \text{ W}\cdot\text{m}^{-2}\cdot\text{sr}^{-1};$$

$$L_{\text{average}} \text{ is smaller than } L_B \text{ for RG2, larger than } L_B \text{ for RG1.}$$

Therefore the projector is classified as RG2 if other hazard elements do not exceed each emission limit for RG2.

B.3.3 14 000 lm projector with two peaks

See Figure B.4.

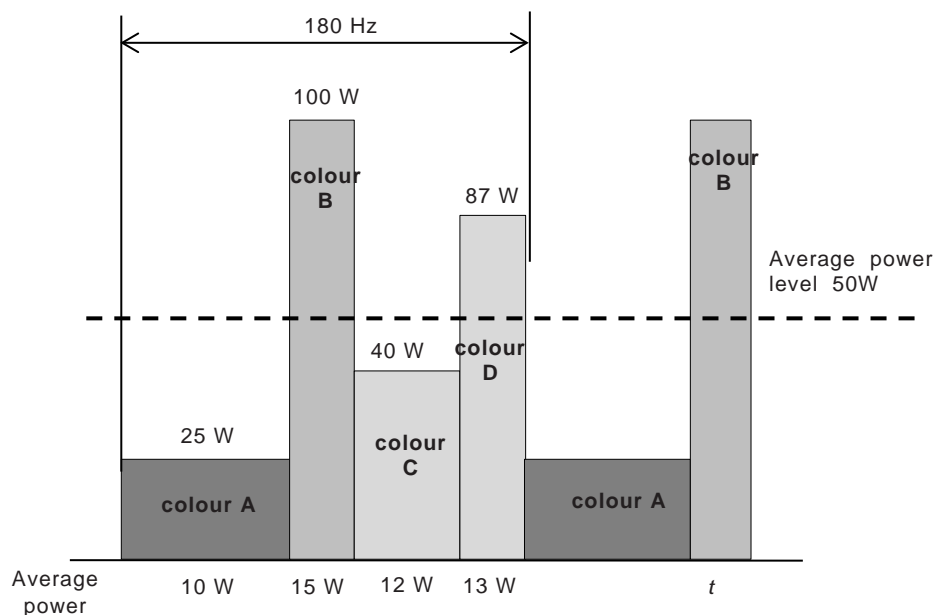

IEC

Figure B.4 – Example with two peaks of pulsed emission

The lenses are fixed.

The maximum throw ratio is 2,0.

The aspect ratio (Horizontal:Vertical) is 4:3.

The apparent source size of a projector is 20 mm in diameter where TR = 2,0.

The distance l_b between the outer surface of the lens and the exit pupil is $l_b = 15,0$ cm.

Assumes:

The spectral weighting functions are 1,0 for visible wavelength.

The luminous efficacy of radiation is 280 lm/W.

The optical emission is pulsed emission from a homogeneous source.

Angular subtense α of the source at a measurement distance of 1 m is

$$\alpha = 0,02 / (0,15 + 1,0) = 1,74 \times 10^{-2} \text{ rad} .$$

The angular subtense α is 14 mrad and the solid angle is

$$\Omega = \pi (0,0174)^2 / 4 = 2,38 \times 10^{-4} \text{ sr} .$$

Illumination area is (0,575m × 0,431 m) at 1 m from the aperture of the projector (TR = 2,0).

The average radiant power P (W) passing through the above illumination area is

$$P = 14\,000 / 280 = 50,0 \text{ W} .$$

The average irradiance E at 1 m distance from the outer surface of the lens is then

$$E = 50,0 / (0,575 \times 0,431) = 202 \text{ W}\cdot\text{m}^{-2} .$$

Therefore,

average radiance is

$$L_{\text{Average}} = E/\Omega = 202 / 2,38 \times 10^{-4} = 8,49 \times 10^5 \text{ W}\cdot\text{m}^{-2}\cdot\text{sr}^{-1} .$$

- Evaluation of retinal thermal hazard

1) Comparison of the average radiance with the CW AEL:

$$L_{\text{Average}} = 8,49 \times 10^5 \text{ W}\cdot\text{m}^{-2}\cdot\text{sr}^{-1} .$$

The time base is

$$t = 0,25 \text{ s} .$$

From Table 6 and Table 7, the maximum angular subtense α_{max} is

$$\alpha_{\text{max}} = 0,2 t^{0,5} \text{ rad} = 0,1 \text{ rad} .$$

Therefore, since $\alpha < \alpha_{\text{max}}$, α is selected for the calculation of AEL.

$$\text{AEL} = 2,0 \times 10^4 \times 0,25^{-0,25} \times (1,74 \times 10^{-2})^{-1} = 1,63 \times 10^6 \text{ W}\cdot\text{m}^{-2}\cdot\text{sr}^{-1} .$$

Averaged radiance < AEL

2) Comparison of the pulse energy and AEL of single pulse multiplied by C_5

Calculate for the total radiance dose of one cycle.

In the case of multiple peaks, the maximum peak value is selected for the calculation of L_{peak} :

$$D = L_{\text{Average}} / 180 = (8,49 \times 10^5) / 180 = 4,72 \times 10^3 \text{ J}\cdot\text{m}^{-2}\cdot\text{sr}^{-1};$$

$$L_{\text{peak}} = L_{\text{Average}} \times 100/50 = 1,70 \times 10^6 \text{ W}\cdot\text{m}^{-2}\cdot\text{sr}^{-1} .$$

- The calculation of AEL

The pulse duration is

$$t_p = D/L_{\text{peak}} = (4,72 \times 10^3) / (1,70 \times 10^6) = 2,78 \times 10^{-3} \text{ s} .$$

From Table 6 and Table 7, the maximum angular subtense α_{\max} is

$$\alpha_{\max} = 0,2 t^{0,5} \text{ rad} = 0,2 \times (2,78 \times 10^{-3})^{0,5} = 10,5 \times 10^{-3} \text{ rad} .$$

Therefore, $\alpha_{\max} < \alpha \leq \alpha_{\max}$ is selected for the calculation of AEL.

- The calculation of C_5

N (the number of pulses that occurs within the time base) is

$$N = 180 \times 0,25 = 45$$

For $\alpha_{\max} < \alpha < 100 \text{ mrad}$, for $N \leq 625$,

$$C_5 = N^{-0,25} = 0,39 .$$

The emission limit of retinal thermal hazard (AEL) is obtained from Table 5.

$$\text{AEL} = 2,0 \times 10^4 \times (2,78 \times 10^{-3})^{-0,25} \times 0,39 \times (10,5 \times 10^{-3})^{-1} = 3,2 \times 10^6 \text{ W} \cdot \text{m}^{-2} \cdot \text{sr}^{-1} .$$

Peak radiance (L_{peak}) is less than AEL of multiple pulse emissions.

- Blue-light hazard

The emission limit of blue-light hazard L_B is obtained from Table 3.

$$L_B \text{ for RG2} = 4\,000\,000;$$

$$L_B \text{ for RG1} = 10\,000;$$

$$L_{\text{Average}} \text{ is smaller than } L_B \text{ for RG2, larger than } L_B \text{ for RG1.}$$

Therefore the projector is classified as RG2 if other hazard elements do not exceed each emission limit for RG2.

Annex C
(informative)

Example of intra-beam of projector sources with millimetre scale

See Figure C.1.

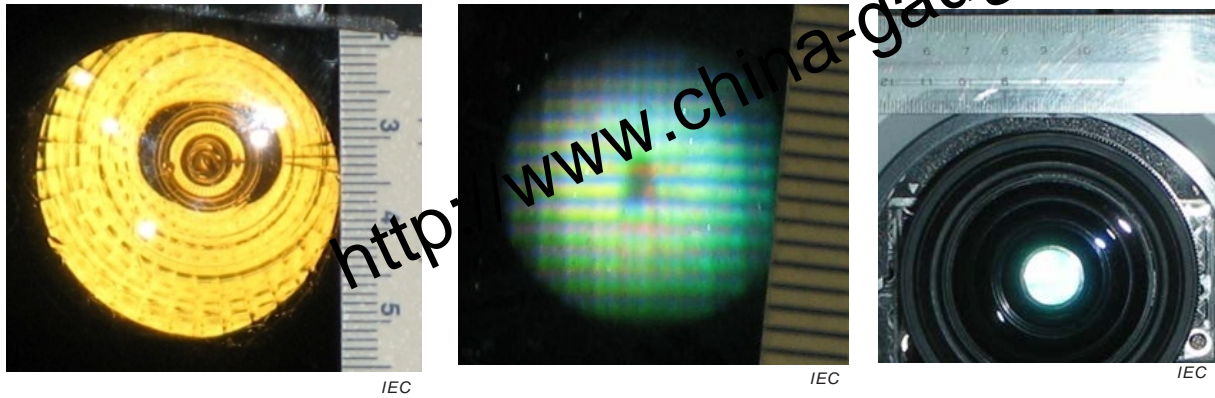

Tungsten projector lamp

Digital MEMS device

LCD projector source

Figure C.1 – Examples of intra-beam images of projector sources with millimetre scale

Annex D (informative)

Measurement distance

The reference distance of 1,0 m for the determination of image projector risk group is based upon a number of considerations. The worst-case default condition of 20 cm provided in IEC 62471:2006 was provided for applications and use conditions totally unknown; however, the use conditions, operation and potential exposure conditions of an image projector are very well known and understood.

The apparent source is well within the projection optics and can vary in exact position relative to the closest plane of human access, the external surface of the projection lens system. Furthermore, the apparent source and beam irradiance will vary little in the immediate near-field of the projection optics in front of the lens. Since the measurement distance from the external surface of the lens system is straightforward to measure, there will be no variation from measurement to measurement. In the immediate near field in front of the projection optics, the irradiance can be substantial, but the eye cannot focus on a bright source.

High-power xenon-short-arc cinema projectors have been in use for more than 50 years, and there has never been a reported public retinal injury, despite the fact that the beams of these projectors exceed current exposure limits to distances on the order of 1 m. An analysis of accidental viewing conditions shows that direct viewing of the projector's bright light beam is not reasonably foreseeable at such close distances. Unintentional viewing is certainly not on-axis nor does it occur with a large, 7-mm pupil. Pupil size greatly affects the amount of light entering the eye.

Blue-light photochemical hazard, from staring into the projector for a long enough duration to pose a blue-light hazard, is not reasonably foreseeable because of the aversion response limit exposure of 0,25 s.

The potential hazard of concern for very bright projectors is the potential risk for retinal thermal injury from viewing the projector source at very close distances. The current exposure limits for retinal thermal injury are created under the assumption of a 7-mm dark-adapted pupil; however, a smaller pupil will exist for reasonably foreseeable, direct-beam viewing conditions. Unintentional viewing would rarely, if ever, involve the macular (central retinal) area, but, rather, the peripheral retina, which further reduces the pupil size before direct macular exposure. Data projectors are normally used in a room with ambient illumination, and reflected light from the screen adds to the ambient light level. A more realistic pupil size of about 3 mm is typical of these settings. Smaller pupil sizes are also required for good acuity (i.e. vision is very poor and acuity low for a 6-mm to 7-mm pupil). A smaller pupil also results from viewing the glare from the projector lens from outside the beam, and as a person approaches the beam.

For typical high luminance projectors, the apparent source (the exit pupil) is at least 15 cm to 20 cm behind the front lens surface and the near-field (collimated) part of the beam is contained within the projector lens or a few centimetres in front of it. Assuming a typical diameter of the exit pupil of 18 mm and the exit pupil being 15 cm behind the front lens surface, the angular subtense of the apparent source at 1 m from the lens equals $18 \text{ mm} / (150 \text{ mm} + 1\,000 \text{ mm}) = 0,016 \text{ rad}$. Considering that in the far-field condition, radiance is constant with distance and the exposure limit scales with the inverse ratio of the angular subtense of the apparent source, the ratio of exposure (constant radiance) and exposure limit increases linearly with distance relative to the exit pupil. On the other hand, the exposure limit expressed as radiance, for a given pupil size, can be scaled with the square of the ratio of the pupil diameter to 7 mm (see also [1]). For instance, a pupil with a diameter of 3,5 mm would result in an increase of the exposure limit by a factor of 4. From these dependencies it follows that a reference distance of 1 m for the determination of the risk group, where the emission limit is based on the assumption of a 7 mm pupil is equivalent to a reference distance of 20 cm from the lens for the assumption of a pupil diameter of 3,8 mm, when the exit pupil is

15 cm behind the lens surface. In other words, if the exposure level at 1 m distance is just below the exposure limit for 0,25 s exposure duration for a 7 mm pupil, it will also be below the exposure limit for exposure at a distance of 20 cm when the pupil diameter is 3,8 mm or less. Thus, for a pupil diameter of 3,8 mm, the classification reference distance of 1 m is equivalent to the conservative reference distance of 20 cm. Additionally, for a complete risk analysis, the safety margin of the exposure limits compared to injury thresholds, particularly for large apparent sources, was taken into consideration. Thus the choice of a 1 m measurement/assessment distance for all projectors can be considered as a conservative value based upon detailed analysis of pupil size and constriction for unintentional viewing, projection optical design and macular exposure.

<http://www.china-gauges.com/>

Annex E (informative)

Hazard distance as a function of modifying optics

This part of IEC 62471 requires in 6.2 that the manufacturer provides HD information if the product's HD exceeds 1 m due to the possible use of modifying optics. This is to assist the end user in estimating the HD of their image projectors.

The given example is derived from a theoretical system with the following characteristics:

- Lumen output: 10 000 lumens (luminous efficiency 251 lm/W)
- Imager chip: 25,4 mm in diagonal
- F number: 2,5
- Lens: variable throw SXGA resolution, 130 mm outer diameter, 20 % off axis capabilities
- Hazard distance: based on $28\,000/\alpha \text{ W}\cdot\text{m}^{-2}\cdot\text{sr}^{-1}$

Figure E.1 displays the radiance of a 10 000 lm projector and its related HD determined from the nearest point of human access. At the point where the AEL crosses the radiance of the system, the hazard distance approaches 1 m. This is at a throw ratio of 4,0.

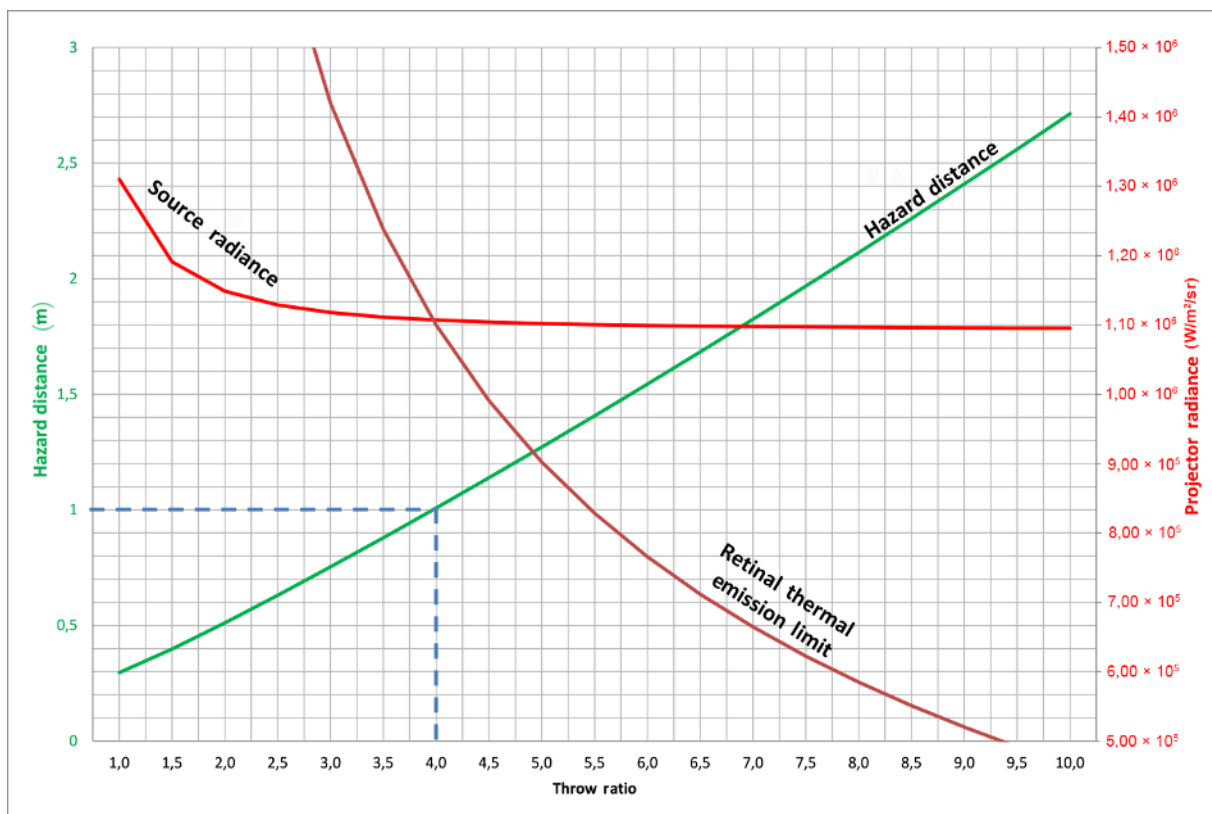

IEC

Figure E.1 – Hazard distance as a function of modifying optics (example)

Bibliography

- [1] ICNIRP Guidelines on limits of exposure to incoherent visible and infrared radiation. *Health Physics* 105(1):74-91; 2013
- [2] IEC 60050-845, *International Electrotechnical Vocabulary – Chapter 845: Lighting*
- [3] IEC TR 60825-14, *Safety of laser products – Part 14: A user's guide*
- [4] IEC 60417, *Graphical symbols for use on equipment* (available at: <http://www.graphical-symbols.info/equipment>)

<http://www.china-gauges.com/>

<http://www.china-gauges.com/>

<http://www.china-gauges.com/>

British Standards Institution (BSI)

BSI is the national body responsible for preparing British Standards and other standards-related publications, information and services.

BSI is incorporated by Royal Charter. British Standards and other standardization products are published by BSI Standards Limited.

About us

We bring together business, industry, government, consumers, innovators and others to shape their combined experience and expertise into standards-based solutions.

The knowledge embodied in our standards has been carefully assembled in a dependable format and refined through our open consultation process. Organizations of all sizes and across all sectors choose standards to help them achieve their goals.

Information on standards

We can provide you with the knowledge that your organization needs to succeed. Find out more about British Standards by visiting our website at bsigroup.com/standards or contacting our Customer Services team or Knowledge Centre.

Buying standards

You can buy and download PDF versions of BSI publications, including British and adopted European and international standards, through our website at bsigroup.com/shop, where hard copies can also be purchased.

If you need international and foreign standards from other Standards Development Organizations, hard copies can be ordered from our Customer Services team.

Subscriptions

Our range of subscription services are designed to make using standards easier for you. For further information on our subscription products go to bsigroup.com/subscriptions.

With **British Standards Online (BSOL)** you'll have instant access to over 55,000 British and adopted European and international standards from your desktop. It's available 24/7 and is refreshed daily so you'll always be up to date.

You can keep in touch with standards developments and receive substantial discounts on the purchase price of standards, both in single copy and subscription format, by becoming a **BSI Subscribing Member**.

PLUS is an updating service exclusive to BSI Subscribing Members. You will automatically receive the latest hard copy of your standards when they're revised or replaced.

To find out more about becoming a BSI Subscribing Member and the benefits of membership, please visit bsigroup.com/shop.

With a **Multi-User Network Licence (MUNL)** you are able to host standards publications on your intranet. Licences can cover as few or as many users as you wish. With updates supplied as soon as they're available, you can be sure your documentation is current. For further information, email bsmusales@bsigroup.com.

BSI Group Headquarters

389 Chiswick High Road London W4 4AL UK

Revisions

Our British Standards and other publications are updated by amendment or revision.

We continually improve the quality of our products and services to benefit your business. If you find an inaccuracy or ambiguity within a British Standard or other BSI publication please inform the Knowledge Centre.

Copyright

All the data, software and documentation set out in all British Standards and other BSI publications are the property of and copyrighted by BSI, or some person or entity that owns copyright in the information used (such as the international standardization bodies) and has formally licensed such information to BSI for commercial publication and use. Except as permitted under the Copyright, Designs and Patents Act 1988 no extract may be reproduced, stored in a retrieval system or transmitted in any form or by any means – electronic, photocopying, recording or otherwise – without prior written permission from BSI. Details and advice can be obtained from the Copyright & Licensing Department.

Useful Contacts:

Customer Services

Tel: +44 845 086 9001

Email (orders): orders@bsigroup.com

Email (enquiries): cservices@bsigroup.com

Subscriptions

Tel: +44 845 086 9001

Email: subscriptions@bsigroup.com

Knowledge Centre

Tel: +44 20 8996 7004

Email: knowledgecentre@bsigroup.com

Copyright & Licensing

Tel: +44 20 8996 7070

Email: copyright@bsigroup.com